

**SIG SAUER**<sup>®</sup>  
when it counts<sup>®</sup>



**P210**<sup>®</sup>

**OWNERS MANUAL: HANDLING & SAFETY INSTRUCTIONS**



**READ THE INSTRUCTIONS AND WARNINGS IN THIS MANUAL CAREFULLY  
BEFORE USING THIS FIREARM; DO NOT DISCARD THIS MANUAL.**

This instruction manual should always accompany this firearm and be transferred with it upon ownership, or when the firearm is loaned or presented to another person.

## State-By-State Warnings

Certain states require, by law, that their own specified warning notices, in larger-than-normal type be conspicuously included by the manufacturer, distributor, or retail dealer with firearms sold in that state. SIG SAUER sells its products in compliance with applicable laws and regulations. Because our products may be sold in these states, we include the following:

### CALIFORNIA: WARNING

"Children are attracted to and can operate firearms that can cause severe injuries or death. Prevent child access by always keeping guns locked away and unloaded when not in use. If you keep a loaded firearm where a child obtains and improperly uses it, you may be fined or sent to prison."

### CONNECTICUT:

"UNLAWFUL STORAGE OF A LOADED FIREARM MAY RESULT IN IMPRISONMENT OR FINE."

### FLORIDA:

"IT IS UNLAWFUL, AND PUNISHABLE BY IMPRISONMENT AND FINE, FOR ANY ADULT TO STORE OR LEAVE A FIREARM IN ANY PLACE WITHIN THE REACH OR EASY ACCESS OF A MINOR UNDER 18 YEARS OF AGE OR TO KNOWINGLY SELL OR OTHERWISE TRANSFER OWNERSHIP OR POSSESSION OF A FIREARM TO A MINOR OR A PERSON OF UNSOUND MIND."

### ADVERTENCIA

"A los niños atraen las armas de fuego y las pueden hacer funcionar. Ellos pueden causarse lesiones graves y la muerte. Evite que los niños tengan acceso a las armas de fuego guardándolas siempre con llave y descargadas cuando no las esté utilizando. Si usted tiene una arma de fuego cargada en un lugar en que un niño tiene acceso a ella y la usa indebidamente, le pueden dar una multa o enviarlo a la cárcel."

### MAINE:

"ENDANGERING THE WELFARE OF A CHILD IS A CRIME. IF YOU LEAVE A FIREARM AND AMMUNITION WITHIN EASY ACCESS OF A CHILD, YOU MAY BE SUBJECT TO FINE, IMPRISONMENT OR BOTH. KEEP FIREARMS AND AMMUNITION SEPARATE. KEEP FIREARMS AND AMMUNITION LOCKED UP. USE TRIGGER LOCKS."

### MARYLAND:

"WARNING: Children can operate firearms which may cause death or serious injury. It is a crime to store or leave a loaded firearm in any location where an individual knew or should have known that an unsupervised minor would gain access to the firearm. Store your firearm responsibly!"

### MASSACHUSETTS:

"WARNING FROM THE MASSACHUSETTS ATTORNEY GENERAL: This handgun is not equipped with a device that fully blocks use by unauthorized users. More than 200,000 firearms like this one are stolen from their owners every year in the United States. In addition, there are more than a thousand suicides each year by younger children and teenagers who get access to firearms. Hundreds more die from accidental discharge. It is likely that many more children sustain serious wounds, or inflict such wounds accidentally on others. In order to limit the chance of such misuse, it is imperative that you keep this weapon locked in a secure place and take other steps necessary to limit the possibility of theft or accident. Failure to take reasonable preventative steps may result in innocent lives being lost, and in some circumstances may result in your liability for these deaths."

"IT IS UNLAWFUL TO STORE OR KEEP A FIREARM, RIFLE, SHOTGUN OR MACHINE GUN IN ANY PLACE UNLESS THAT WEAPON IS EQUIPPED WITH A TAMPER RESISTANT SAFETY DEVICE OR IS STORED OR KEPT IN A SECURELY LOCKED CONTAINER."

### NEW JERSEY:

"IT IS A CRIMINAL OFFENSE TO LEAVE A LOADED FIREARM WITHIN EASY ACCESS OF A MINOR."

## NEW YORK CITY, NY:

"THE USE OF A LOCKING DEVICE OR SAFETY LOCK IS ONLY ONE ASPECT OF RESPONSIBLE FIREARMS STORAGE. FOR INCREASED SAFETY, FIREARMS SHOULD BE STORED UNLOADED AND LOCKED IN A LOCATION THAT IS BOTH SEPARATE FROM THEIR AMMUNITION AND INACCESSIBLE TO CHILDREN AND OTHER UNAUTHORIZED PERSONS."

## NORTH CAROLINA:

Any person who resides in the same premises as a minor, owns or possesses a firearm, and stores or leaves the firearm (i) in a condition that the firearm can be discharged and (ii) in a manner that the person knew or should have known that an unsupervised minor would be able to gain access to the firearm, is guilty of a Class 1 misdemeanor if a minor gains access to the firearm without the lawful permission of the minor's parents or a person having charge of the minor and the minor:

- (1) Possesses it in violation of G.S. 14-269.2(b)
- (2) Exhibits it in a public place in a careless, angry, or threatening manner;
- (3) Causes personal injury or death with it not in self defense; or
- (4) Uses it in the commission of a crime.

## TEXAS:

"IT IS UNLAWFUL TO STORE, TRANSPORT, OR ABANDON AN UNSECURED FIREARM IN A PLACE WHERE CHILDREN ARE LIKELY TO BE AND CAN OBTAIN ACCESS TO THE FIREARM."

## WISCONSIN:

"IF YOU LEAVE A LOADED FIREARM WITHIN THE REACH OR EASY ACCESS OF A CHILD YOU MAY BE FINED OR IMPRISONED OR BOTH IF THE CHILD IMPROPERLY DISCHARGES, POSSESSES, OR EXHIBITS THE FIREARM."

Please check with your licensed retailer, state police, or local police for additional warnings, which may be required by local law or regulation. Such regulations change constantly, and local authorities are in the best position to advise you on such legal matters.

## THE BASIC RULES OF SAFE FIREARMS HANDLING

1. ALWAYS treat every firearm as if it were loaded.
2. ALWAYS be sure the barrel is clear of any obstruction.
3. ALWAYS be sure of your backstop, what lies beyond, and the safety of bystanders before you shoot.
4. ALWAYS use clean, dry, original factory-made ammunition of the proper type and caliber for your firearm.
5. ALWAYS wear ear protection and safety glasses when shooting.
6. ALWAYS carry your firearm so that you can control the direction of the muzzle if you fall or stumble.
7. NEVER shoot at a flat surface or water.
8. DO NOT leave an unattended firearm loaded. Firearms and ammunition should be stored separately, locked if possible, beyond the reach of children, careless adults, and unauthorized users.
9. NEVER allow your firearm to be used by anyone who has not read and understood this operator's manual.
10. DO NOT point any firearm, loaded or unloaded, at any undesired target.
11. NEVER fire your rifle near an animal unless it is trained to accept the noise: an animal's startled reaction could injure it or cause an accident.
12. NEVER drink alcoholic beverages or take drugs before or during shooting, as your vision and judgment could be seriously impaired, making your firearm handling unsafe.

**⚠ WARNING – LOCKING DEVICES**

This firearm was originally sold with a key-operated locking device. While it can help provide secure storage for your unloaded firearm, any locking device can fail. All firearms are designed to fire if they are loaded and the trigger is pulled. Therefore, never install the locking device inside the trigger guard or in any way that makes it possible to pull the trigger! Do not leave the keys in the lock.

The ultimate responsibility for secure storage of any firearm must depend upon its owner and his or her individual circumstances. Firearms should be stored unloaded, in a secure location, separate from their ammunition.

**NEVER INSTALL THE LOCKING DEVICE INSIDE THE TRIGGER GUARD**

To maximize effectiveness and reduce the chances of malfunction or damage to a firearm, ALWAYS refer to the locking device's manufacturer directions for installation and removal of the device.

**FIREARMS SAFETY IS YOUR RESPONSIBILITY**

This owner's manual is designed to assist you in learning how to use and care for your SIG SAUER® pistol properly.

Only when you are certain that you fully understand this manual and can properly carry out its instructions, should you practice loading and firing your firearm with live ammunition. Having a firearm in your possession is a full-time job; you cannot guess and you cannot forget. You must know how to use your firearm safely.

If you have any doubts about your ability to handle or use this firearm safely, you should seek supervised instruction. The SIG SAUER Academy<sup>SM</sup> provides all levels of firearms safety and skill training, from beginner to expert.

For more information contact:



[www.sigsaueracademy.com](http://www.sigsaueracademy.com) • (603) 610-3400  
Epping, New Hampshire

**SAFETY MUST BE THE FIRST AND CONSTANT CONSIDERATION OF EVERY PERSON WHO HANDLES FIREARMS AND AMMUNITION.**

For more information about safety, responsible firearms ownership, and shooting sports, contact:

National Rifle Association (NRA) of America  
11250 Waples Mill Road, Fairfax, VA 22030-7400 • 1-800-672-3888  
[www.nra.com](http://www.nra.com)

## TABLE OF CONTENTS

Topic	Page
State-By-State Warnings	2
The Basic Rules of Safe Firearms Handling	5
Locking Devices	6
Warnings of Great Importance	10
1.0 Safety Rules	11
1.1 Protect Your Eyes and Ears	11
2.0 Mechanical Characteristics and Weapon Theory	12
2.1 Weapon Description	12
2.1.1 General	12
2.1.2 Principal Features	12
2.2 Main Parts	13
3.0 Ammunition	14
4.0 Handling	18
4.1 Preparation Instructions	18
4.2 Manual Safety Equipped Pistols	18
4.3 Loading the Magazine	18
4.4 Loading the Pistol (Ready to Fire)	19
4.5 Reloading During Shooting	20
5.0 Firing	22
5.1 Clearing a Jam	23
5.2 Firing the Pistol	24
6.0 Unloading the Pistol	25
6.1 Unloading the Pistol (Magazine Not Empty)	26
6.2 Unloading the Pistol (Magazine Empty, Slide Open)	27

Topic	Page
7.0 Procedures in Case of Malfunction	29
7.1 Troubleshooting Guide	30
7.2 Minimize Malfunctions	31
8.0 Maintenance	32
8.1 Pistol Disassembly	33
8.2 Magazine Disassembly	35
8.3 Cleaning the Pistol	36
8.4 Pistol Assembly	37
8.5 Magazine Assembly	39
8.6 Function Verification	40
9.0 Sights	44
9.1 General Information	44
9.2 Windage Adjustment	45
9.3 Elevation Adjustment	46
10.0 Transportation and Storage	50
11.0 Service and Parts Policy	51
11.1 Parts Policy	51
11.2 Service Policy	52
11.3 Shipping Firearms for Repair	52
11.4 Ordering Parts	54
12.0 Parts Diagram	56
13.0 Technical Specifications	57
Warranty Information	58

## WARNINGS OF GREAT IMPORTANCE ARE FOUND WITHIN THIS MANUAL

Locking Devices	6	Jam	29, 33
Alterations	10, 43	Maintenance	32, 40
Ammunition	14, 17	Disassembly	32, 33, 34, 35
Lodged Bullet	16	Cleaning	36
Lead Exposure	17	Assembly	37, 39
Loaded Pistol	19, 21	Inspection	42
Trigger	22	Alterations	10, 43
Malfunction	22	Sight Adjustment	44, 45
Ejection	23	Storage	50
Handling	23	Parts Purchasers	51
Unloading	25, 28	Shipping	54

### OTHER CAUTIONS AND WARNINGS APPEAR THROUGHOUT THE MANUAL

## FIREARMS ARE DANGEROUS WEAPONS

### READ THE INSTRUCTIONS AND WARNINGS IN THIS MANUAL THOROUGHLY AND CAREFULLY BEFORE USING.

#### **WARNING – ALTERATIONS**



This product was designed to function properly in its original condition. Alterations can make it unsafe. Do not alter any part or add or substitute any parts or accessories not manufactured by SIG SAUER, Inc. for this pistol.

### DO NOT ALTER ANY FIREARM

## 1.0 Safety Rules

The safety warnings in this manual are important. By understanding the dangers inherent in the use of any firearm, and by taking the precautions described herein, you can experience a higher level of safety in the use of your pistol. Failure to heed any of these warnings may result in serious injury to you or others, as well as severe damage to the firearm or other property.

PISTOLS are classified as FIREARMS and are sold by SIG SAUER with the specific understanding that we shall not be responsible in any manner whatsoever for malfunctioning of the firearm, physical injury or property damage resulting in whole or in part from:

- criminal or negligent discharge;
- improper or careless handling;
- unauthorized modifications;
- defective, improper, hand-loaded, or reloaded ammunition;
- corrosion;
- neglect; or
- other influences beyond our direct and immediate control.

This limitation applies regardless of whether liability is asserted on the basis of contract, negligence, or strict liability (including any failure to warn). Under no circumstance shall SIG SAUER, Inc. be liable for incidental or consequential damages, such as loss of use of property, commercial loss, and loss of earnings or profits.

## 1.1 Protect Your Eyes and Ears

Always wear safety glasses that meet the requirements of American National Standards Institute (ANSI) Z87.1 and ear plugs or “ earmuff ” type protectors whenever you are shooting. Always make certain that persons close to you are similarly protected. Unprotected eyes may be injured by powder, gas, carbon residue, lubricant, metallic particles, or similar debris that may emanate occasionally from any firearm in normal use. Without ear protection, repeated exposure to shooting noise may lead to cumulative, permanent hearing loss.

## 2.0 Mechanical Characteristics and Weapon Theory

### 2.1 Weapon Description

#### 2.1.1. General

The Sig Sauer P210 pistol is a modern precision firearm incorporating the latest technical advances in weapon design for military, law enforcement and sporting use. The P210 is a mechanically locked, short recoil operated pistol with semi-automatic reloading. Firing takes place with each press of the trigger resulting in one round being fired until the magazine is empty. The slide remains open after the last round has been fired from the magazine. The thumb safety of the P210 can be engaged and still allow for manipulation of the slide. This allows the user to clear a loaded chamber with the safety engaged.

#### 2.1.2 Principal Features

- The P210 pistol is a single-action only (SAO) design.
- Full length frame rails enhance accuracy.
- Positive locking between the barrel and slide.
- Disassembly for cleaning does not require tools.

### 2.2 Main Parts

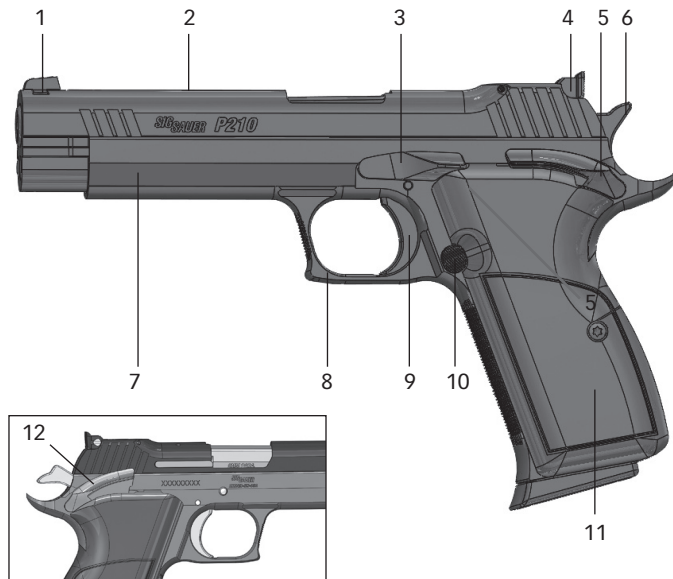

- |                       |                   |                                |
|-----------------------|-------------------|--------------------------------|
| 1 - Front Sight       | 6 - Hammer        | 10 - Magazine Catch            |
| 2 - Slide             | 7 - Frame         | 11 - Grip Panel                |
| 3 - Slide Catch Lever | 8 - Trigger Guard | 12 - Ambidextrous Thumb Safety |
| 4 - Rear Sight        | 9 - Trigger       |                                |
| 5 - Thumb Safety      |                   |                                |

*Note: Refer to section 12 for a detailed parts list and diagram.*

### 3.0 Ammunition

1. Use only high-quality, original, factory-manufactured ammunition. Do not use cartridges that are dirty, wet, corroded, bent, or damaged. Do not oil cartridges. Do not spray aerosol-type lubricants, preservatives, or cleaners directly onto cartridges or where excess spray may flow into contact with cartridges. Lubricant or other foreign matter on cartridges can cause potentially dangerous ammunition malfunctions. Only use ammunition of the caliber for which your firearm is chambered. The proper caliber is permanently engraved on your firearm; never attempt to use ammunition of any other caliber.

2. The use of reloaded, "remanufactured" hand-loaded, or other non-standard ammunition voids all warranties. Reloading is a science and improperly loaded ammunition can be extremely dangerous. Severe damage to the firearm and serious injury to the shooter or to others may result. Always use ammunition that complies with the industry performance standards established by the Sporting Arms and Ammunition Manufacturers' Institute, Inc. (SAAMI) of the United States or ammunition manufactured to military specifications.

#### **⚠ WARNING – AMMUNITION (CARTRIDGE) NOTICE**

SIG SAUER SPECIFICALLY DISCLAIMS RESPONSIBILITY FOR ANY DAMAGE OR INJURY WHATSOEVER OCCURRING IN CONNECTION WITH, OR AS A RESULT OF, THE USE IN ANY SIG SAUER FIREARM OF FAULTY, NON-STANDARD, "REMANUFACTURED" HAND-LOADED (RELOADED) AMMUNITION, OR CARTRIDGES OTHER THAN THOSE FOR WHICH THE FIREARM WAS ORIGINALLY CHAMBERED.

3. Firearms may be severely damaged and serious injury to the shooter or to others may result from any condition causing excessive pressure inside the chamber or barrel during firing. Excessive pressure can be caused by obstructions in the barrel, propellant powder overloads, the use of incorrect cartridges, or defectively assembled cartridges. In addition, the use of a dirty, corroded, or damaged cartridge can lead to a burst cartridge case and consequent damage to the firearm and personal injury from the sudden escape of high-pressure propellant gas within the firearm's mechanism.

4. Immediately stop shooting and check the barrel for a possible obstruction whenever:

- You have difficulty in, or feel unusual resistance in, chambering a cartridge
- A cartridge misfires (does not go off)
- The mechanism fails to extract a fired cartridge case
- Unburned grains of propellant powder are discovered spilled in the mechanism
- A shot sounds weak or abnormal. In such cases it is possible that a bullet is lodged partway down the barrel. Firing a subsequent bullet into the obstructed barrel can damage the firearm and cause serious injury to the shooter or to bystanders

5. Bullets can become lodged in the barrel:

- If the cartridge has been improperly loaded without propellant powder, or if the powder fails to ignite (ignition of the cartridge primer alone will push the bullet out of the cartridge case, but usually does not generate sufficient energy to expel the bullet completely from the barrel).
- If the bullet is not properly seated in the cartridge case. When such a cartridge is extracted from the chamber without being fired, the bullet may be left behind in the bore at the point where the rifling begins. Subsequent chambering of another cartridge may push the first bullet further into the bore.



6. If there is any reason to suspect that a bullet is obstructing the barrel, immediately unload the firearm and look through the bore. It is not sufficient to merely look in the chamber.

A bullet may be lodged some distance down the barrel where it cannot easily be seen.

### **⚠ WARNING – LODGED BULLET**

IF A BULLET IS IN THE BORE, DO NOT ATTEMPT TO SHOOT IT OUT BY USING ANOTHER CARTRIDGE OR BY BLOWING IT OUT WITH A BLANK OR ONE FROM WHICH THE BULLET HAS BEEN REMOVED. SUCH TECHNIQUES CAN GENERATE EXCESSIVE PRESSURE, DAMAGE THE FIREARM, AND CAUSE SERIOUS PERSONAL INJURY.

If the bullet can be removed with a cleaning rod, clean any unburned powder grains from the bore, chamber, and mechanism before resuming shooting. If the bullet cannot be dislodged by tapping it with a cleaning rod, send the firearm to SIG SAUER.

7. Dirt, corrosion, or other foreign matter on a cartridge can impede complete chambering and may cause the cartridge case to burst upon firing. The same is true of cartridges that are damaged or deformed.
8. Do not oil cartridges, and be sure to wipe the chamber clean of any oil or preservative before commencing to shoot. Oil interferes with the friction between cartridge case and chamber wall that is necessary for safe functioning, and subjects the firearm to stress similar to that imposed by excessive pressure.
9. Use lubricants sparingly on the moving parts of your firearm. Avoid excessive spraying of any aerosol firearm care product, especially where it may get on ammunition. All lubricants and aerosol spray lubricants, in particular, can penetrate cartridge primers and cause misfires. Some highly penetrative lubricants can also migrate inside cartridge cases and cause deterioration of the propellant powder; on firing, the powder may not ignite. If only the primer ignites, there is danger that the bullet may become lodged in the barrel.

### **⚠ WARNING – AMMUNITION**



Death, serious injury, and damage can result from the use of wrong ammunition, bore obstructions, powder overloads, or incorrect cartridge components. Always wear shooting glasses and hearing protectors.

#### **IMPROPER AMMUNITION DESTROYS FIREARMS**

### **⚠ WARNING – LEAD EXPOSURE**



Discharging firearms in poorly ventilated areas, cleaning firearms, or handling ammunition may result in exposure to lead and other substances known to the state of California to cause birth defects, reproductive harm, and other serious physical injury. Maintain adequate ventilation at all times. Wash hands thoroughly after exposure.

#### **SHOOTING OR CLEANING FIREARMS MAY EXPOSE YOU TO LEAD**

## 4.0 Handling

### 4.1 Preparation Instructions

If you have the pistol and ammunition, and have read and understood all of the safety instructions, you are now ready to use the pistol.

### 4.2 Loading the Magazine

1. Ensure the magazine is the proper type and caliber for the pistol.
2. Press down on the magazine follower with the cartridge case rim. Ensure the bullet is facing the front of the magazine.
3. Push the cartridge to the rear and under the magazine lips.
4. Repeat until the magazine holds the desired number of cartridges.

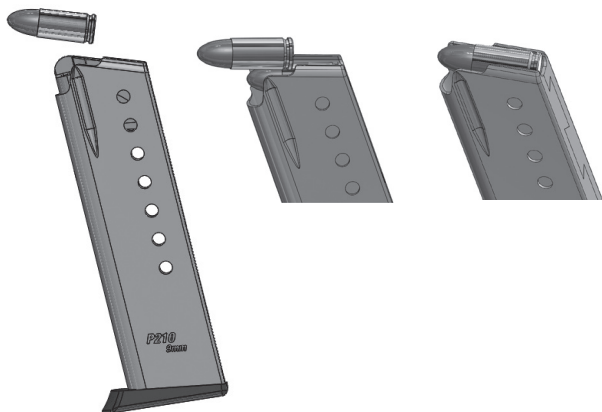

### 4.3 Loading the pistol (ready to fire)

1. Point the pistol in a safe direction.
2. Engage the thumb safety by pressing it upward.
3. Insert a full magazine and ensure it locks in the magazine well.
4. Pull the slide back fully and release, allowing the slide to return forward and lock.

**⚠ WARNING – LOADED PISTOL**

**THE PISTOL IS NOW LOADED AND READY TO FIRE.**

Step 2

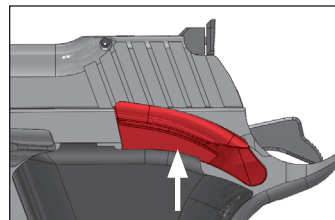

Step 3

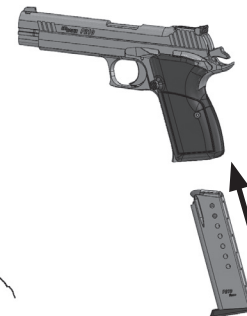

Step 4



## 4.4 Reloading During Shooting

When the last round in the magazine is expended, the slide will be locked back in the open position by the slide stop.



1. Engage Manual Safety.
2. Depress the magazine catch.
3. Remove the empty magazine.
4. Insert a loaded magazine, making sure it is engaged.

Step 1

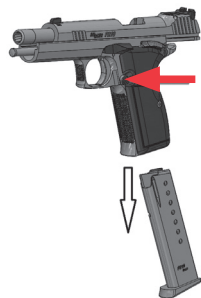

Step 2



Step 3

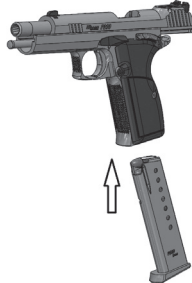

5. Release the slide by:
  - a. Pressing down on the slide catch lever or,
  - b. Pulling back on the slide and release.

Step 4a

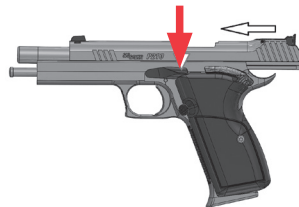

Step 4b



**⚠ WARNING – LOADED PISTOL**

**THE PISTOL IS NOW LOADED AND READY TO FIRE.**

Always make sure the muzzle is pointed in a safe direction! Never attempt to load or unload any firearm inside a vehicle, building, or other confined space (except a properly constructed shooting range). Enclosed areas frequently offer no completely safe direction to point the firearm; if an accidental discharge occurs, there is great risk of bodily injury or property damage. Before loading, always clean all grease and oil from the bore and chamber, and check to be certain that no obstruction is in the barrel. Any foreign matter in the barrel could result in a bulged or burst barrel or other damage to the firearm, and could cause serious injury to the shooter or to others.

## 5.0 Firing

### ⚠ WARNING – TRIGGER

DO NOT TOUCH THE TRIGGER UNTIL YOU ARE ACTUALLY READY TO FIRE THE PISTOL.

Keep the muzzle pointed in a safe direction and your finger away from the trigger when cocking any firearm.

Never fire any firearm with your finger, hand, face, or other part of your body over or adjacent to the ejection port, or in any position where you may be struck by reciprocating movement of the breech. Both the ejection of empty cartridge cases and the movement of the breech are part of the normal operating cycle of firearms, and pose no safety hazard to the shooter if the firearm is held in a normal grip and fired at arm's length.

Never allow other persons to stand beside you where they might be struck by an ejected cartridge case. The case is hot, and may be ejected with sufficient force to cause a burn, cut, or other injury. Wear safety glasses to protect eyes. Make certain there is a clear, unobstructed path for safe ejection of the fired case. Remember, the case may bounce off a hard object nearby and strike you or someone else.

### ⚠ WARNING – MALFUNCTION

If, while shooting, your firearm develops a mechanical malfunction or binding, or "spits" powder/gas, or if a cartridge primer is punctured, or a cartridge case is bulged or ruptured, or if the report on firing does not sound quite right, STOP SHOOTING IMMEDIATELY! It may be dangerous to continue. UNLOAD THE FIREARM – DO NOT try "one more shot." Take the firearm and the ammunition to a gunsmith for examination.

## 5.1 Clearing a Jam

While shooting any firearm, an unfired cartridge or fired cartridge case may occasionally become jammed between the slide and the barrel. WHILE KEEPING THE MUZZLE POINTED IN A SAFE DIRECTION, clear the jam as follows:

1. Remove the magazine.
2. Pull back the slide and lock it to the rear by pushing up on the slide stop.
3. The jammed cartridge or case now can be removed by shaking it out or by picking it out.

### ⚠ WARNING – EJECTION



The slide opens and shuts quickly while firing. Keep face and hands away from it. Hot brass and powder gas is ejected quickly and can burn you. Always wear safety glasses and hearing protectors.

**SLIDE OPENS FAST – HOT BRASS EJECTED**

### ⚠ WARNING – HANDLING



All SIG SAUER pistols incorporate effective mechanical safeties to ensure they only fire when the trigger is pressed. However, like any mechanical device, exposure to acute conditions (e.g. shock, vibration, heavy or repeated drops) may have a negative effect on these safety mechanisms and cause them to fail to work as designed. After suspected exposure to these conditions, have the firearm checked by a certified armorer before using. Mechanical safeties are designed to augment, and not replace safe handling practices. **Careless and improper handling of any firearm can result in unintentional discharge.**

## 5.2 Firing the Pistol

1. Aim the pistol at a safe target.
2. Disengage the thumb safety by pressing it downward.
3. Place finger on the trigger and pull back to discharge.

Step 2

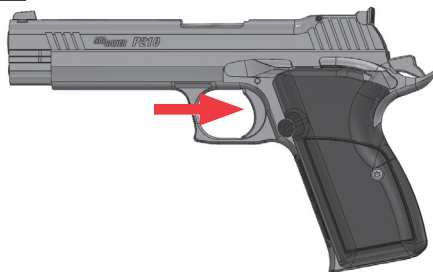
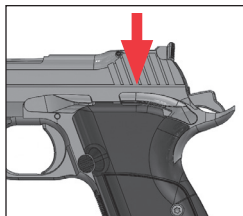

4. Keep pistol aimed at the target and continue to fire as necessary.
5. Remove the magazine, unload and clear the pistol (see section 6.0 "Unloading the Pistol"). If the pistol is fired until the magazine is empty, the slide will remain locked to the rear. If firing is to continue, reload the pistol (see section 4.4 "Reloading During Shooting").

## 6.0 Unloading the Pistol

### ⚠ WARNING – UNLOADING



Removing cartridges from the magazine does not prevent the pistol from being fired! When there is a cartridge in the chamber, the cartridge will discharge if the trigger is pulled. It is absolutely essential for the user to know how to completely unload the pistol. "Completely" means emptying the magazine and removing a chambered cartridge.

---

**PISTOL WILL FIRE WITH MAGAZINE EMPTY OR REMOVED**

---

## 6.1 Unloading the Pistol (Magazine Not Empty)

1. Keep the muzzle pointed in a safe direction.
2. Depress the magazine catch and remove the magazine.
3. Pull the slide back to the stop and engage the slide catch lever. The round is ejected and the slide is locked open.
4. Visually and manually check the chamber to ensure the pistol is completely free of ammunition.
5. Depress the slide catch lever, causing the slide to close.
6. Unload the magazine.

Step 2



Step 3



Step 4

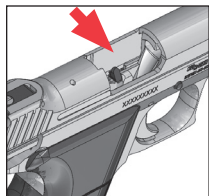

Step 5



Step 6

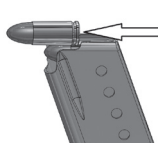

## 6.2 Unloading the Pistol (Magazine Empty, Slide Open)

1. Keep the muzzle pointed in a safe direction.
2. Depress the magazine catch and remove the magazine.
3. Visually and manually check the chamber to ensure the pistol is completely free of ammunition.
4. Depress the slide catch lever, causing the slide to close.

Step 2

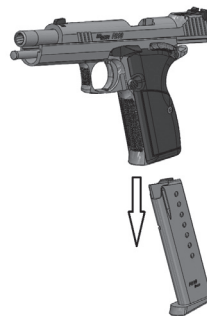

Step 3

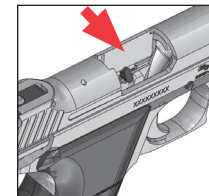

Step 4



Always make sure the muzzle is pointed in a safe direction! Remember to clear the chamber after the magazine has been removed.

Never assume that any firearm is unloaded until you have personally checked it, visually and physically!

After every shooting practice, make a final check to be certain the firearm is unloaded before leaving the range.

## ⚠ WARNING – UNLOADING

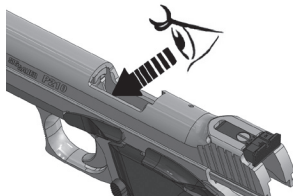

Removing cartridges from the magazine does not prevent the pistol from being fired! When there is a cartridge in the chamber, the cartridge will discharge if the trigger is pulled. It is absolutely essential for the user to know how to completely unload the pistol. “Completely” means emptying the magazine and removing a chambered cartridge.

**PISTOL WILL FIRE WITH MAGAZINE EMPTY OR REMOVED**

## 7.0 Procedures in Case of Malfunction (“Jam”)

Follow the malfunction mitigation procedures if:

- You notice that a cartridge is difficult to chamber
- A cartridge does not go off
- The mechanism fails to extract a fired cartridge case
- You discover unburned grains of propellant powder spilled in the mechanism
- A shot sounds or feels weak or abnormal

### ⚠ WARNING – JAM

LIVE ROUND JAM MAY NOT EJECT.

Firearms work reliably if properly maintained. If there is a malfunction during firing:

1. Keep the pistol pointed in a safe direction with your finger off the trigger.
2. Remove and secure the magazine.
3. Move the slide rearward and forward to clear any cartridge case in or near the chamber. Visually and manually inspect the chamber.
4. If you suspect that a bullet is lodged in the bore, field strip your pistol and check to see if the barrel is blocked. If there is a bullet lodged in the bore, return the pistol to SIG SAUER (see section 11.3 “Shipping Firearms for Repair”).

### ⚠ WARNING – JAM

IF A BULLET IS IN THE BORE, DO NOT ATTEMPT TO SHOOT IT OUT BY USING ANOTHER CARTRIDGE, OR BY BLOWING IT OUT WITH A BLANK OR A CARTRIDGE FROM WHICH THE BULLET HAS BEEN REMOVED. THIS CAN GENERATE EXCESSIVE PRESSURE, DAMAGE THE FIREARM AND CAUSE SERIOUS PERSONAL INJURY OR DEATH.

## 7.1 Troubleshooting Guide

Malfunction	Cause	Correction
<b>Feed</b>		
No round fed into the chamber	Magazine not properly inserted or magazine is deformed or dirty	Insert magazine properly or change magazine
Slide does not close easily or completely	Pistol or cartridge is fouled (dirty) or pistol is too heavily lubricated	Clean and lubricate pistol and/or replace the ammunition
	Incorrect ammunition	Replace ammunition
	Pistol requires service	Return to SIG SAUER
<b>Extraction/Ejection</b>		
After firing, the case stays in the chamber or is jammed in the ejection port	Insufficient recoil due to dirt	Clean and lubricate the pistol
	Light hold or limp wrist	Solid grip, rigid hold
	Low-powered ammunition	Change ammunition
	Pistol requires service	Return to SIG SAUER
<b>Ignition</b>		
Trigger is fully pulled but round does not fire	Striker obstructed	Inspect, clean and lubricate the pistol
	Faulty ammunition	Manually cycle in next round
	Pistol requires service	Return to SIG SAUER

### **⚠ WARNING – JAMS**

If your pistol stops firing with a live round in the chamber of a hot barrel (a misfire or jam), remove the round immediately. If you cannot remove the round within 10 seconds, remove the magazine and wait at least 15 minutes with the pistol pointing in a safe direction. This way, neither the user nor any other person would be injured by the possibility of a round “cooking-off” (a round detonating due to the heat of the barrel). Keep your face away from the ejection port while clearing a hot chamber.

## 7.2 Minimizing Malfunctions (“Jams”)

Malfunctions can largely be avoided by cleaning the pistol (see section 8.3 “Cleaning the Pistol”).

- After each firing session
- Whenever a buildup of firing residue is suspected
- Whenever the pistol is exposed to extreme environmental conditions (rain, snow, freezing temperatures, etc.)



## 8.0 Maintenance

### ⚠ WARNING – MAINTENANCE

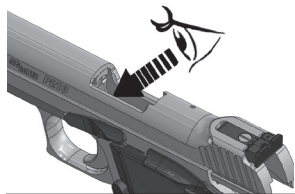

Verify the magazine is removed – visually and physically confirm the pistol is unloaded before attempting disassembly or performing any maintenance steps. Failure to ensure the firearm is unloaded could result in unintentional discharge, causing injury or death.

**VERIFY THE FIREARM IS UNLOADED**

### ⚠ WARNING – DISASSEMBLY



Do not attempt to disassemble your pistol beyond the point explained in this manual. Further disassembly should only be done at the factory or certified SIG SAUER Armorer. Some of the components require special skills, tools and fixtures for disassembly.

**DO NOT DISASSEMBLE BEYOND INSTRUCTIONS**

## 8.1 Pistol Disassembly

1. Unload the pistol (see section 6.0 “Unloading the Pistol”).
2. Retract the slide approximately 5mm to the rear.
3. Push the slide catch lever from right to left, and remove it from the frame.

### ⚠ WARNING – DISASSEMBLY

Slide is under spring tension. Maintain positive control during slide removal to prevent damage or injury. Wear eye protection.

4. Move the complete slide assembly (slide, barrel, recoil spring and guide) forward and off of the frame rails.

*Step 2*



*Step 3*



*Step 4*

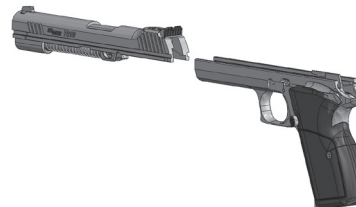

**⚠ WARNING – DISASSEMBLY**

The recoil spring and guide are under spring tension and not firmly attached to the slide. Use caution to prevent injury or damage to the pistol. Wear eye protection.

5. Push the recoil spring assembly forward slightly and lift from rear to remove the recoil spring and guide from the slide. The recoil spring, spring guide, and washer are serviceable only by replacement. Disassembling the recoil spring assembly is not authorized.
6. Remove the barrel from the slide by pulling upward slightly and to the rear. This level of disassembly is sufficient to allow a thorough cleaning and lubrication after shooting.

Step 5

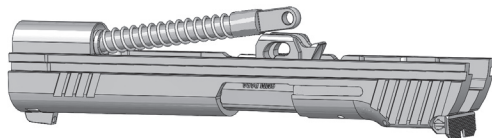

Step 6

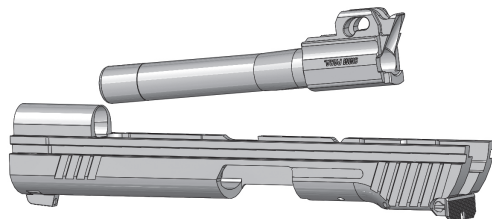

## 8.2 Magazine Disassembly

1. Locate the bottom of the magazine floorplate.
2. Using a punch, cleaning rod, or similar tool, depress the magazine insert and push the magazine floorplate forward until it is clear of the magazine tube.

**⚠ WARNING – DISASSEMBLY**

The magazine spring is compressed. Guard the magazine insert and magazine spring with your thumb to control the release of magazine spring tension. Uncontrolled release can cause injury. Wear eye protection.

3. Remove the magazine insert from the magazine tube.
4. Remove the magazine spring and the follower from the magazine tube. This level of disassembly is sufficient to allow a thorough cleaning after shooting.

Step 2

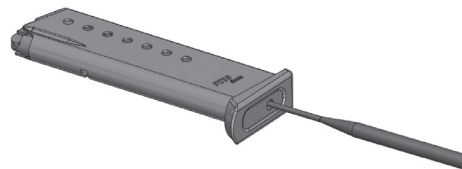

Step 3

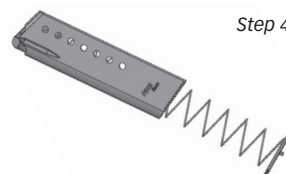

Step 4

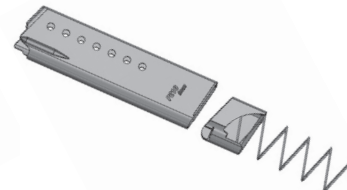

## 8.3 Cleaning the Pistol

### ⚠ WARNING – CLEANING

Never clean the barrel from the muzzle end; do not use a steel wire brush as it can damage the smooth surface of the barrel. Use a suitable cleaning rod with a good bearing and bronze or nylon bristle brush of the correct caliber.

Solvents can be harmful to the surface finish of the pistol. Read and follow the manufacturer's warnings before using solvents or cleaners. Wear eye protection.

#### Avoid over-lubrication of components.

The SIG P210 is a precision firearm. Care should be taken when cleaning the barrel. Be cautious of damaging the crown of the muzzle with the cleaning rod when scrubbing the barrel.

1. Moisten a cotton patch of the correct caliber size with solvent and attach to the cleaning rod.
2. From the chamber end, make two or three passes through the barrel. Let the solvent soak for a while to loosen any residue.
3. Moisten another patch and run it through the bore.
4. Attach the bore brush to the cleaning rod and make several passes through the bore from the chamber end of the barrel.
5. Run another wet patch through the bore followed by a dry patch. Repeat with dry patches until they exit the muzzle clean.
6. Remove dirt from guides of the frame, inside and outside of slide, recoil spring guide and recoil spring with a brush or cleaning patch. Lightly lubricate same surfaces with a cloth impregnated with gun oil or gun grease.
7. Lightly oil bores of the barrel and chamber. Remove any excess lubricant.

## 8.4 Pistol Assembly

1. Verify the pistol is clear of all foreign matter.
2. Insert the barrel into the slide and pull it rearward making sure the barrel lugs lock into the slide.

Step 2

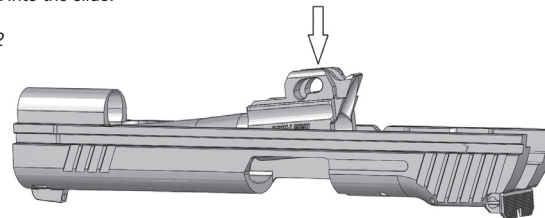

### ⚠ WARNING – ASSEMBLY

The recoil spring and guide are under spring tension. Use caution to prevent injury or damage to the pistol. Wear eye protection.

3. Insert the recoil spring guide assembly into the slide.

Step 3

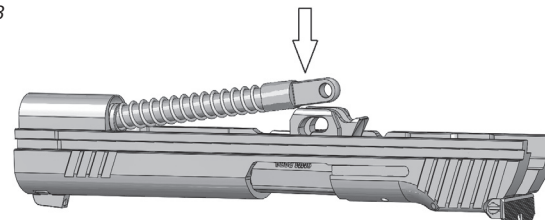

- Carefully guide the slide onto the frame rails from the front.
- Grasp the slide and pull it rearward until you align the through hole of the frame with the lug of the barrel and the hole of the recoil spring guide.
- Push the slide catch lever in from the left side of the frame and through the lug of the barrel. It should slightly protrude from the right side of the frame.
- Release the slide allowing it to move forward and lock into place.
- Retract the slide and lock it to the rear by pressing up on the slide catch lever.

Step 4



Step 5

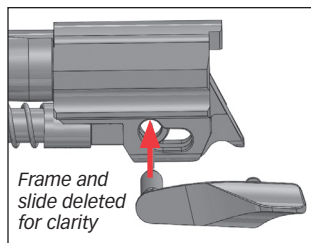

## 8.5 Magazine Assembly

- Set the magazine follower on top of the magazine spring and insert into the bottom of the magazine tube.

### ⚠ WARNING – ASSEMBLY

The magazine spring is being compressed during assembly. Guard the magazine insert and magazine spring with your thumb to control magazine spring tension. Uncontrolled release can cause injury. Wear eye protection.

- Insert the magazine spring fully into the magazine tube until the magazine insert is flush with the magazine tube bottom.
- Holding the magazine insert in place, slide the magazine floorplate onto the magazine tube lips until the magazine floorplate is locked in place by the magazine insert.

Step 1

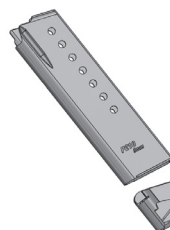

Step 2

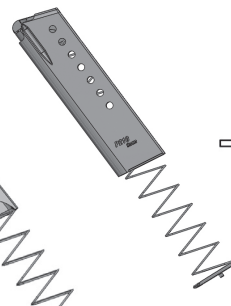

Step 3

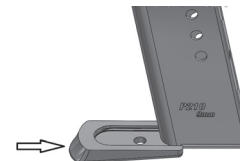

## 8.6 Function Verification

The function check is performed to verify proper assembly. It should be performed after the completion of repairs and after each cleaning and assembly of the pistol.

### ⚠ WARNING – MAINTENANCE

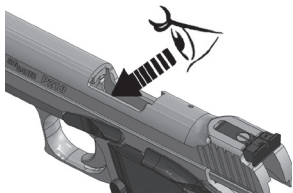

Verify the magazine is removed – visually and physically confirm the pistol is unloaded before attempting disassembly or performing any maintenance steps. Failure to ensure the firearm is unloaded could result in unintentional discharge, causing injury or death.

#### VERIFY THE FIREARM IS UNLOADED

1. Ensure the firearm is unloaded and clear as previously described.
2. Insert an empty magazine. Check that it locks into the magazine well by the magazine catch.
3. Fully retract the slide until it is captured by the slide stop.



4. Press the magazine catch. The mag should drop free from the pistol.
5. Depress the slide stop. The slide should travel to its forward and locked position.
6. Engage the thumb safety by rotating it upward.
7. Attempt to press the trigger to the rear. The hammer should not fall.
8. Disengage the thumb safety by rotating it downward.
9. Press the trigger and keep it held to the rear. The hammer should fall.

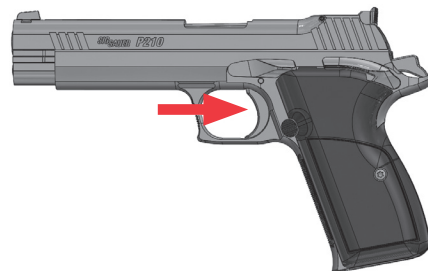

10. While keeping the trigger pressed rearward, retract and release the slide. The hammer should now be cocked.
11. Release pressure from the trigger. You should hear a light click as the trigger resets. The hammer should stay in the cocked position.
12. Press the trigger to the rear. The hammer should fall.

### Magazine Inspection

1. Inspect condition of magazine tube.
2. Verify the magazine floorplate is properly held in place.
3. The follower should not bind as it moves up and down inside the tube.

### Pistol Exterior

1. Inspect condition of the finish.
2. Check grips for tightness.
3. Verify sights are secure.

## ⚠ WARNING – INSPECTION

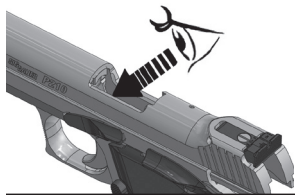

Never use a firearm or magazine that shows signs of damage or fails a function check. Verify the magazine is the correct model and caliber for the pistol. If the condition or function of the pistol or magazine is suspect, return the pistol or magazine to SIG SAUER for evaluation.

**VERIFY THE CONDITION AND FUNCTION**

## ⚠ WARNING – ALTERATIONS



This product was designed to function properly in its original condition. Alterations can make it unsafe. Do not alter any part or add or substitute any parts or accessories not manufactured by SIG SAUER for this pistol.

**DO NOT ALTER ANY FIREARM**

## 9.0 Sights

### 9.1 General Information

The SIG SAUER P210 pistols are fitted with either drift adjustable fixed sights or adjustable micrometer rear sights depending on the specific model. The P210 is a precision pistol designed to be sighted in at 25 yards.

#### **⚠ WARNING – SIGHT ADJUSTMENT**

Sight corrections should ONLY be performed on an unloaded firearm. Manipulating the sights on a loaded firearm could result in unintentional discharge, causing injury or death. Visually and physically confirm the pistol is unloaded before making sight adjustments.

---

**DO NOT ADJUST THE SIGHTS ON A LOADED FIREARM!**

---

### 9.2 Windage (Left/Right) Adjustment

Sighting is corrected by shifting the front sight laterally and by installing front sights of various sizes.

#### **⚠ WARNING – SIGHT ADJUSTMENT**

Corrections to drift adjustable fixed sights should only be made with a front sight pusher tool to avoid damaging the finish of the pistol. They should only be performed by a competent gunsmith or certified SIG SAUER Armorer.

If the impact of the shot is:

Too far left: shift front sight to the left

Too far right: shift front sight to the right

Moving the front sight to the side by 0.5 mm/0.0196 inches corresponds to a horizontal impact shift of 9.6cm/3.78 inches at a distance of 25 m.

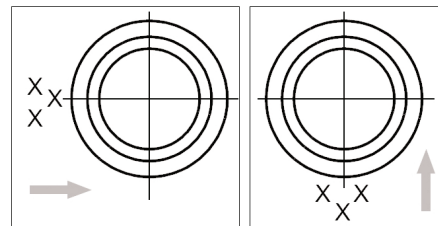

Impact left of point of aim

Impact low of point of aim

### 9.3 Elevation (Up/Down) Adjustment

Number	Height
05	6.01mm/.236"
06	5.88 mm/.231"
08	5.60 mm/.220"

Changing the front sight by one size corresponds to a vertical impact shift of 1.06 inches over a distance of 25 yards.

If the point of impact is too high, install a larger/taller front sight. If the point of impact is too low, install a smaller/shorter front sight.

### 9.4 Micrometer Sight

The rear micrometer sight of the SIG SAUER P210 offers the shooter a precise method of adjusting the point of impact for both elevation and windage. The top screw is used for adjusting elevation. The screw on the right side of the sight aperture is used for adjusting windage.

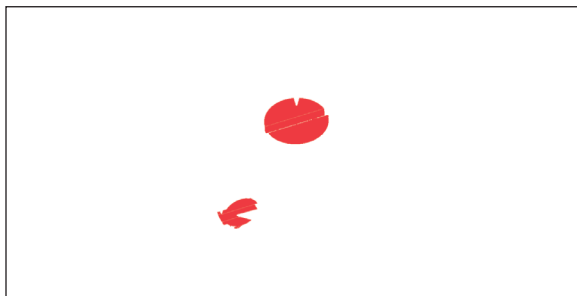

#### 9.4.1 Micrometer Sight Adjustments for Windage

Using the center reference line of the rear sight aperture in conjunction with the stadia lines on the rear sight base, rotate the windage screw in the appropriate direction to move the rear sight. The "R" on the right side of the sight base indicates the direction of the point of impact when the screw is turned.

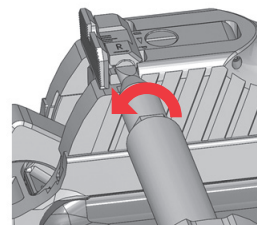

MOVES IMPACT TO THE LEFT

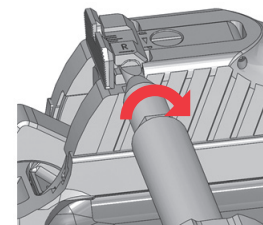

MOVES IMPACT TO THE RIGHT

Too far left: Turn the windage screw counterclockwise (direction of the arrow under the "R") to move impact to the right

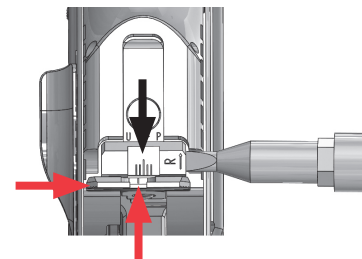



Too far right: Turn the windage screw clockwise (opposite direction of arrow) to move impact to the left

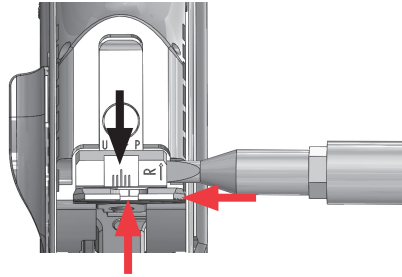

One click of windage adjustment will move the point of impact 0.09 mm/.0035 inches at 25 yards.

## 9.4.2 Micrometer Sight Adjustment for Elevation

Too low: Turn the elevation screw counterclockwise to raise the rear sight and raise the point of impact.

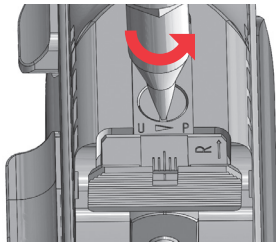

Too high: Turn the elevation screw clockwise to lower the rear sight and lower the point of impact.

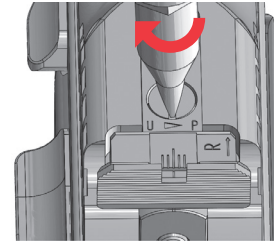

One click of elevation adjustment will move the point of impact 0.07 mm/.0027 inches.

## 10.0 Transportation and Storage

When transporting your firearm to and from shooting activities, keep it unloaded for your safety and for the safety of others. When storing your firearm, keep it separated from ammunition, under lock and key if possible, and out of the reach of children and other inexperienced or unauthorized persons.

### ⚠ WARNING – STORAGE



Never place or store any firearm in such a manner that it may be dislodged. Firearms should always be stored securely and unloaded, away from children and other unauthorized users. Use the locking device originally supplied with this firearm for storage. The use of a locking device or safety lock is only one aspect of responsible firearms storage. For increased safety, firearms should be stored unloaded and locked in a location that is both separate from their ammunition and inaccessible to children and any other unauthorized person.

---

**STORE SECURELY AND UNLOADED**

---

## 11.0 Service and Parts Policy

### 11.1 Parts Policy

Our Service Department maintains a full complement of replacement parts. Even though most gunsmiths have the knowledge, training, and the ability to make necessary repairs to your firearm, the skill and workmanship of any particular gunsmith is totally beyond our control.

Should your firearm ever require service, we strongly recommend that you return it to SIG SAUER (see section 11.3 “Shipping Firearms for Repair”). A firearm is a precision instrument and some replacement parts will require individual fitting to ensure correct operation. A wrong part, improper fitting, or incorrect mechanical adjustment may result in an unsafe condition or dangerous malfunction, damage to the firearm, or cause possible serious injury to the shooter or others.

IF ANY PART IS ORDERED WITHOUT RETURNING THE FIREARM TO SIG SAUER, the customer bears full responsibility for ensuring that the part supplied is correct for their particular firearm and is properly installed and fitted by a qualified gunsmith.

SIG SAUER CANNOT BE RESPONSIBLE FOR THE FUNCTIONING OF ANY FIREARM IN WHICH REPLACEMENT PARTS ARE INSTALLED BY OTHERS.

### ⚠ WARNING – PARTS PURCHASERS

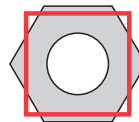

It is the purchaser’s responsibility to be absolutely certain that any parts ordered from the factory are correctly fitted and installed. Firearms are complicated mechanisms and **IMPROPER FITTING OF PARTS MAY RESULT IN A DANGEROUS MALFUNCTION, DAMAGE TO THE FIREARM, AND SERIOUS INJURY TO THE SHOOTER AND OTHER PERSONS.** The purchaser and installer of parts must accept full responsibility for the correct adjustment and functioning of the firearm after such installation. **PARTS MUST FIT CORRECTLY**

## 11.2 Service Policy

If you have questions concerning the performance or servicing of your firearm, please write or call:

**SIG SAUER, Inc.**  
**Attention: Customer Service**  
**18 Industrial Drive, Exeter, NH 03833**  
**Phone: (603) 610-3000 ext. 1**  
**Fax: (603) 766-7002**

**IF YOU DO NOT UNDERSTAND THE INSTRUCTIONS FOR OPERATING YOUR PISTOL, IT IS YOUR RESPONSIBILITY TO CALL OUR CUSTOMER SERVICE DEPARTMENT AT (603) 610-3000 EXT. 1 BEFORE USING YOUR FIREARM.**

## 11.3 Shipping Firearms for Repair

In the event you need to return your firearm to the SIG SAUER Service Department, here's what to do:

1. First contact Customer Service at (603) 610-3000 ext. 1 for an RMA number, which will allow SIG SAUER to track the status of your return from its receipt at SIG SAUER through its return to you. Please do not send your firearm until you obtain an RMA number.
2. Make sure that the chamber and magazine(s) are unloaded and that no ammunition is included with your returned firearm.
3. Package the firearm securely to prevent damage. Enclose a letter that includes your name, street address, daytime phone number, model and serial number, and a detailed description of the problem you have experienced or the work you want performed. With the exception of extra magazines, do not include any other accessories such as scopes or mounts.

4. Generally, an individual may ship firearms to the manufacturer for repair or service. Some states and localities, however, prohibit this. If you live in such an area, the firearms must be shipped by and returned to a federally licensed firearms dealer.

5. Federal law prohibits persons who do not possess a Federal Firearms License from shipping a firearm via the U.S. Postal Service. (Note: any shipment of firearms outside U.S. borders is subject to the export laws of the United States and to the valid laws of the specific country, which you must strictly follow; prior to exporting any firearm you should seek legal counsel.)

6. SIG SAUER is not responsible for any firearm until it is received, nor for damage incurred during shipment.

7. Ship your firearms insured and prepaid (we do not accept collect shipments) to:

**SIG SAUER, Inc.**  
**Attention: Service Department**  
**18 Industrial Drive Exeter, NH 03833**

Don't forget to write your RMA number on the package.

**A copy of this instruction manual should always accompany this pistol and be transferred with it upon change of ownership.**

## 11.4 Ordering Parts

SIG SAUER offers a limited number of repair parts that can be purchased and installed by the end user without voiding the warranty of the firearm.

In the event you want to order parts for your firearm, contact Customer Service at (603) 610-3000 ext. 1.

Have available the serial number of your firearm and a description of the part(s) you wish to order. A parts list and diagram of the pistol is provided in section 12.0.

Please refer to the Service and Parts Policy.

This page intentionally left blank.

### **⚠ WARNING – SHIPPING**



Before shipping any firearm, be absolutely certain that the firearm and its magazines are unloaded.

DO NOT ship ammunition with a firearm. Failure to follow this warning could result in unintentional discharge, causing injury or death.

---

**VERIFY THE FIREARM IS UNLOADED**

---

## 12.0 Parts Diagram

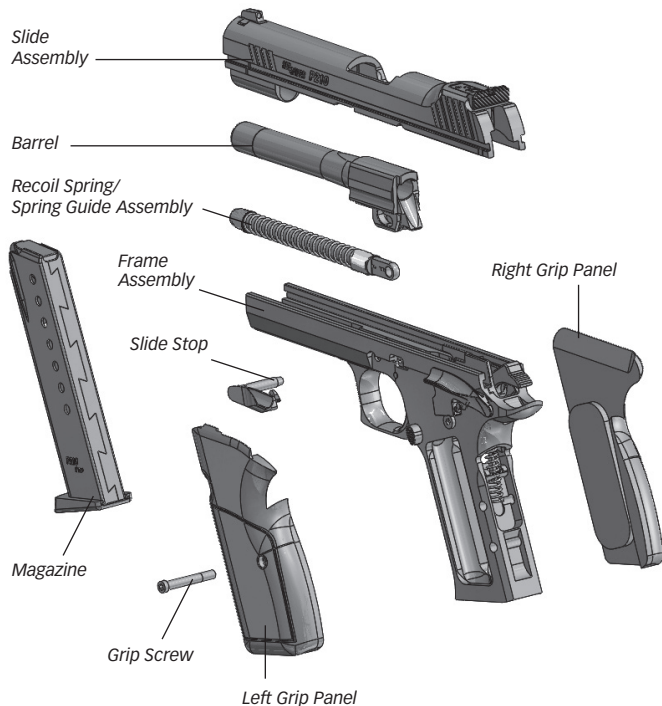

## 13.0 Technical Specifications

The following information applies to all P210 models.

- Single Action Only (SAO)
- 9mm x 19 Caliber

	4 inch Carry	5 inch Standard	5 inch Target	6 inch Target
<b>Length</b>	7.4"	8.4"	8.4"	9.4"
<b>Height</b>	5.25"	5.25"	5.25"	5.25"
<b>Width</b>	1.37"	1.37"	1.54"	1.54" (w/ambi)
<b>Barrel Length</b>	4.25"	5.0"	5.0"	6.0"
<b>Rifling Twist</b>	1:10	1:10	1:10	1:10
<b>Rifling Grooves</b>	6	6	6	6
<b>Sight Radius</b>	5.5"	6.5"	6.7"	7.7"
<b>Weight w/Mag</b>	TBD	33.4oz	36.9oz	43.0oz
<b>Magazine Mag only</b>	2.5oz	2.5oz	2.5oz	2.5oz
<b>Magazine Capacity</b>	8+1	8+1	8+1	8+1

Specifications are subject to change without notice.

## SIG SAUER® Limited Lifetime Firearms Warranty

SIG SAUER warrants that the enclosed firearm was originally manufactured free of defects in material, workmanship and mechanical function. For the lifetime of the original purchaser, SIG SAUER agrees to correct any defect in the firearm for the original purchaser by repair, adjustment or replacement, at SIG SAUER's option, with the same or comparable quality components (or by replacing the firearms at SIG SAUER's option); provided, however, that the firearm is returned unloaded and freight prepaid to:

**SIG SAUER  
18 Industrial Drive  
Exeter, NH 03833**

This limited warranty is null and void if the firearm has been misused, damaged (by accident or otherwise), fired with handloaded, reloaded or improper ammunition, fired with an obstruction in the barrel, damaged through failure to provide reasonable and necessary maintenance as described in the manual accompanying the firearm, or if unauthorized repair or any alteration, including of a cosmetic nature, has been performed on the firearm. This limited warranty does not apply to normal wear and tear of any parts. Subject to the foregoing, this limited warranty confers the right to have the covered firearm or its parts repaired, adjusted or replaced exclusively upon the original purchaser, which right is not transferable to any other person. No implied warranties of any kind are made herein and this warranty does not apply to any accessory items attached or appurtenant to the firearm. In no event shall SIG SAUER be liable for any incidental or consequential damages arising from or in connection with this limited warranty.

## Notes:

---

---

---

---

---

---

---

---

---

---

---

---

---

---

---

---

---

---

---

---

---

---

---

**SIGSAUER**<sup>®</sup>  
*when it counts*<sup>®</sup>

[www.sigsauer.com](http://www.sigsauer.com)

**FOR PRODUCT SERVICE ON THIS MODEL,  
PLEASE CALL (603) 610-3000 EXT. 1**

72 Pease Boulevard, Newington, NH 03801 USA