

UX

TREVOX

BREAK BARREL AIR PISTOL



EN Operating instructions 3 – 10

DE Bedienungsanleitung 11 – 18

FR Mode d'emploi 19 – 26

ES Manual de instrucciones 27 – 34

IT Istruzioni per l'uso 35 – 42

RU Инструкция по эксплуатации 43 – 50

PL Instrukcja obsługi 51 – 58

TR Kullanım kılavuzu 59 – 66

AIRGUN

cal. 4,5 mm (.177) Pellet

INTRODUCTION | EINLEITUNG | INTRODUCTION | INTRODUCCIÓN INTRODUZIONE | ИНСТРУКЦИЯ | WSTĘP | İÇİNDEKİLER

| |  |  |  |  |
|-----------|---|---|---|---|
| EN | Description | Operation | Maintenance | Safety instructions |
| DE | Benennung | Bedienung | Pflege | Sicherheitshinweise |
| FR | Désignation des pièces | Emploi | Entretien | Consignes de sécurité |
| ES | Designación | Reglaje | Cuidados | Instrucciones de seguridad |
| IT | Descrizione | Utilizzo | Manutenzione | Norme di sicurezza |
| RU | Наименование | Техническое обслуживание | Уход | Указания по технике безопасности |
| PL | Nazewnictwo | Obsługa | Czyszczenie | Wskazówki dot. bezpieczeństwa |
| TR | Parçaların adları | Kullanım | Bakım | Güvenlik bilgileri |



SAFE GUN HANDLING

EN

You should be fully familiar with the proper and safe handling of your gun. The basic principles of gun safety require you to always apply the following rules when handling the firearm.

- Always treat a gun as if it was loaded.
- Always put the safety of a gun to “safe” when loading it so that there can be no unintentional discharge.
- Keep your finger away from the trigger. It should be straight and should rest on the trigger guard.
- Only use the kind of projectiles suitable for your gun.
- Always keep the muzzle pointed in a safe direction.
- This gun may only be discharged in your own house, on authorized shooting ranges and inside enclosed private property. It is to be made sure that no projectile can leave the enclosed property.
- Keep the danger area of the projectile in mind.
- Never transport a loaded gun. Only load your gun when you intend to fire it.
- Never aim your airgun at persons or animals. Avoid ricochets. Never fire at smooth, hard surfaces or water.
- Before you discharge your gun, make sure that target and surrounding area are safe.
- Always make sure that the gun is not loaded when you transport it or take it from another person.
- Make sure that you always have full control over the muzzle of your gun, even if you stumble or fall down.
- Safety shooting glasses should always be worn when firing the gun.
- Always store your gun in a safe place and in unloaded condition. Unauthorized persons (persons not familiar with the use of guns, children) must not have access to it. Ammunition is to be kept in a separate place.
- This gun and its instruction manual may only be passed on to persons
 - who are fully familiar with its use and
 - who have reached the legally stipulated minimum age in the respective country.
- Modifications or repairs of guns are only to be effected by authorized agencies or by a skilled gunsmith.
- Never leave a loaded gun unattended.
- Only unloaded guns are to be handed over to another person.

REPAIR

A gun that does not work properly is dangerous. Do not attempt to repair this pistol if it needs service. Incorrect assembly could lead to dangerous malfunctions.

Caution: Repairs should only be completed by Umarex authorized centres.



CAUTION

For your own safety and the safety of others, carefully read these instructions before using this gun. Buyers and owners must observe all rules concerning the use and ownership of air guns. Modifying this gun may result in a change of its classification under guns law and is therefore prohibited. In such cases the manufacturer's warranty will immediately become void.



WARNING

Do not brandish or display this airgun in public - it may confuse people and may be a crime. Police and others may think this airgun is a firearm. Do not change the coloration and markings to make it look more like a firearm. That is dangerous and may be a crime.

WARRANTY

During the legal warranty period, which begins on the date of purchase, Umarex will repair or replace your gun at no charge provided the defect was not caused by you. Return your gun to an authorized dealer along with a description of the problem and proof of purchase.

The air guns manufactured by UMAREX GmbH & Co. KG are made according to the regulations of the PTB (Physikalisch-Technische Bundesanstalt), German federal law, the CIP regulations and the technical know-how of UMAREX GmbH & Co. KG.

We will not assume any liability whatsoever if this product is exported to territories outside of Germany and as a consequence does not comply with domestic legal requirements of these territories. It will be the sole responsibility of the importer to ensure compliance with local laws and regulations.

TECHNICAL DATA

| | |
|-----------------------|---------------------------------|
| Item no. | 2.4369 |
| | Trevox |
| System / Power Source | Gas Piston |
| Caliber / Ammo | 4,5 mm (.177) Pellets |
| Capacity | 1 rounds (Pellets) |
| Energy | < 7,5 J |
| Velocity | up to 150 m/s |
| Sights | Fixed front and rear adjustable |
| Trigger | Single Action |
| Color | black |
| Safety | manual |
| Barrel length | 257 mm |
| Dangerous area up to | 460 m |
| Weight | 1450 g |
| Length | 460 mm |



DESCRIPTION

EN

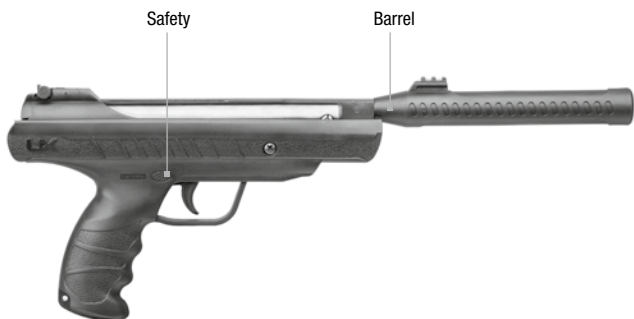
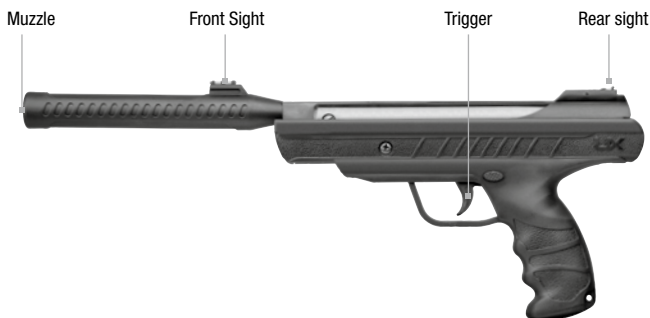



SAFETY

EN

CAUTION

- Only handle your gun in its safe condition.
- Always make sure that the muzzle points in a safe direction.



PROBLEM SOLUTIONS



PROBLEMS

Faulty shooting direction

Gun does not shoot

Low shooting speed

POSSIBLE CAUSES

| | Safety activated | Dirty barrel | Extreme temperatures | Wrong ammunition | Ammunition badly loaded | Sight not properly adjusted | | | |
|---------------------------|------------------|--------------|----------------------|------------------|-------------------------|-----------------------------|--|--|--|
| Faulty shooting direction | | ● | ● | ● | ● | ● | | | |
| Gun does not shoot | ● | | | ● | ● | | | | |
| Low shooting speed | | ● | ● | ● | ● | | | | |



COCKING AND LOADING

EN

CAUTION

Only use pellets cal. 4,5 mm (.177).

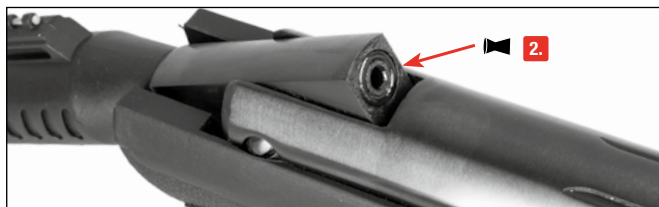
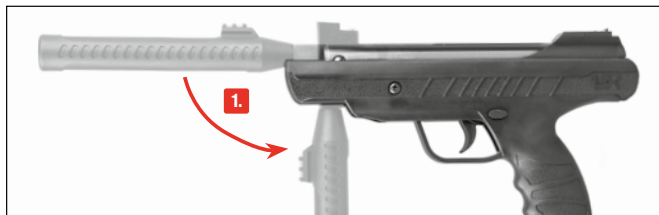



SIGHTS

EN

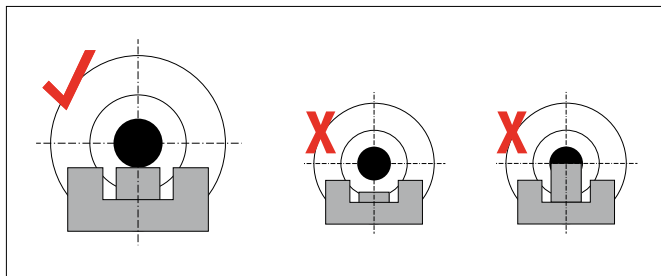

ADJUSTABLE REAR SIGHT

Height adjustment

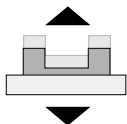

Shots are too high



turn to the left

Shots are too low



turn to the right

Windage adjustment



Shots are left of center



turn to the right

Shots are right of center



turn to the left



1. Put safety on "fire"



2. Pull trigger





BARREL CLEANING

EN

CAUTION

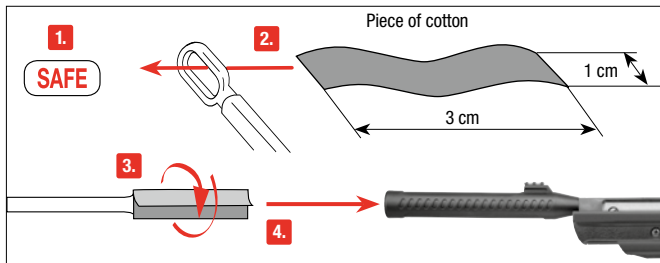

- Unload the gun before cleaning the gun.
- Do not force the rod into the barrel, as this could cause damage.
- Occasionally clean the metal parts on the outside. Use a cloth which has been slightly dampened with some gun oil.
- Never drip silicone oil directly into the barrel.



Put the safety on "safe". Prepare a thin rod with a length of approx. 30 cm. Attach a piece of cotton fabric to its end and clean the barrel with some silicone oil.



Sie sollten mit der richtigen, sicheren Handhabung Ihrer Waffe vertraut sein. Im Hinblick auf die Grundregeln zum sicheren Schießen bedenken Sie, dass jede Berührung mit der Waffe als Handhabung verstanden wird.

- Behandeln Sie jede Waffe so, als wäre sie geladen.
- Die Waffe beim Laden stets sichern, so dass sich kein Schuss ungewollt lösen kann.
- Finger immer außerhalb des Abzugsbügels halten und nur zum Schuss an den Abzug legen.
- Verwenden Sie nur für diese Waffe vorgesehene Geschosse.
- Halten Sie die Mündung stets in eine sichere Richtung.
- Das Schießen ist nur in der eigenen Wohnung, auf polizeilich zugelassenen Schießständen und im befriedeten Besitztum erlaubt, wenn das Geschoss dieses beim Schuss nicht verlasen kann. Hierbei den Gefahrenbereich des Geschosses beachten.
- Transportieren Sie niemals eine geladene Waffe. Laden Sie nur, wenn Sie schießen möchten.
- Waffe niemals auf Menschen oder Tiere richten. Vermeiden Sie Querschläger. Schießen Sie niemals auf glatte, harte Oberflächen oder auf Wasserflächen.
- Vergewissern Sie sich vor dem Schuss, dass Ziel und Umgebungsbereich sicher sind.
- Kontrollieren Sie immer, ob die Waffe ungeladen ist, wenn Sie sie transportieren oder von einer anderen Person übernehmen.
- Vergewissern Sie sich, dass Sie auch beim Stolpern oder Stürzen die Richtung der Mündung kontrollieren können.
- Aus Sicherheitsgründen sollte beim Schießen eine Schutzbrille getragen werden.
- Aufbewahren der Waffe stets sicher und ungeladen vor unerlaubtem Zugriff Unbefugter (ungeschulte Personen, Kinder, Personen unter 18 Jahren) und getrennt von der Munition.
- Weitergabe dieser Waffe mit der Bedienungsanleitung nur an Personen
 - die mit dieser Waffe genauestens vertraut und
 - bei Waffen mit -Zeichen mindestens 18 Jahre alt sind.
- Druckluftwaffen mit Energie > 0,5 Joule aber ohne -Zeichen sind erwerbscheinpflichtig.
- Jegliche Veränderungen oder Reparaturen von Waffen sollten nur von fachkundigen Firmen oder vom Büchsenmacher durchgeführt werden.
- Legen Sie niemals eine geladene Waffe aus der Hand.
- Geben Sie nur entladene Waffen an andere Personen weiter.

REPARATUR

Eine Waffe, die nicht einwandfrei funktioniert, ist gefährlich. Es ist schwierig, eine Waffe selbst zu reparieren, und falscher Zusammenbau kann zu gefährlichen Funktionsstörungen führen.

**Achtung: Lassen Sie die Waffe nur von einem autorisierten Fachhändler/
Büchsenmacher überprüfen und reparieren.**

**ACHTUNG**

Zu Ihrer eigenen und zur Sicherheit anderer lesen Sie die Bedienungsanleitung vollständig und sorgfältig durch, bevor Sie mit der Waffe erstmalig hantieren. Käufer und Besitzer haben die Pflicht, alle Regeln über den Gebrauch und den Besitz von Druckluftwaffen zu befolgen. Jede Änderung an dieser Waffe kann zu einer Änderung der waffenrechtlichen Einstufung führen und ist somit unzulässig. Die Gewährleistung des Herstellers erlischt in diesem Fall sofort.

**WARNUNG**

Diese Druckluftwaffe nicht in der Öffentlichkeit zeigen oder mit ihr drohen - es führt zu Verwechslungen mit echten Waffen und gilt als Straftat. Ändern Sie keinesfalls die Farbe und Markierungen der Druckluftwaffe, um ihr Aussehen mehr einer realen Schusswaffe anzugleichen. Dies ist gefährlich und gilt als Straftat.

GARANTIE

Innerhalb des gesetzlich festgelegten Zeitraumes ab Kaufdatum repariert oder ersetzt Ihnen Umarex Ihre Waffe kostenlos, falls der Defekt nicht durch Eigenverschulden aufgetreten ist. Geben Sie die Waffe einem autorisierten Händler, beschreiben Sie ihm das Problem und fügen Sie den entsprechenden Kaufbeleg bei. Die von UMAREX GmbH & Co. KG hergestellten Druckluftwaffen werden gemäß den Zulassungsvorschriften der Physikalisch-Technischer Bundesanstalt (PTB), dem Bundesgesetz, den CIP-Vorschriften und dem waffen-technischen Know-how der Firma UMAREX GmbH & Co. KG hergestellt. Somit übernehmen wir keine Haftung, falls diese Ware nach dem Export ins Ausland nicht den dort geltenden Rechtsvorschriften entsprechen sollte und dem Besitzer/Käufer juristische Schwierigkeiten und Konsequenzen daraus entstehen sollten.

TECHNISCHE DATEN

| | |
|-----------------------------|---------------------------------|
| Art.Nr. | 2.4369 |
| | Trevox |
| System / Antrieb | Gas Piston |
| Kaliber / Munition | 4,5 mm (.177) Diabolo |
| Kapazität | 1 Schuss (Diabolo) |
| Energie | < 7,5 J |
| Geschwindigkeit | bis zu 150 m/s |
| Visierung | Korn fest und Kimme verstellbar |
| Abzug | Single-Action |
| Farbe | Schwarz |
| Sicherung | manuell |
| Lauflänge | 257 mm |
| Max. Gefahrenbereich bis zu | 460 m |
| Gewicht | 1450 g |
| Gesamtlänge | 460 mm |



BENENNUNG

DE

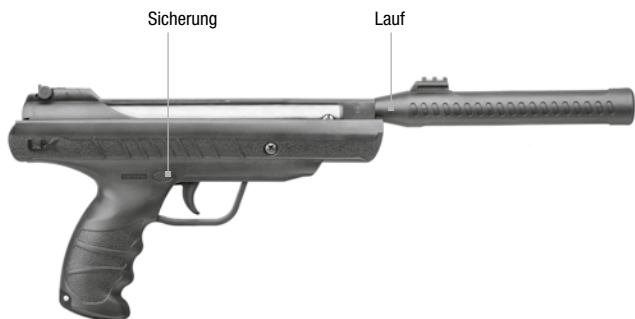
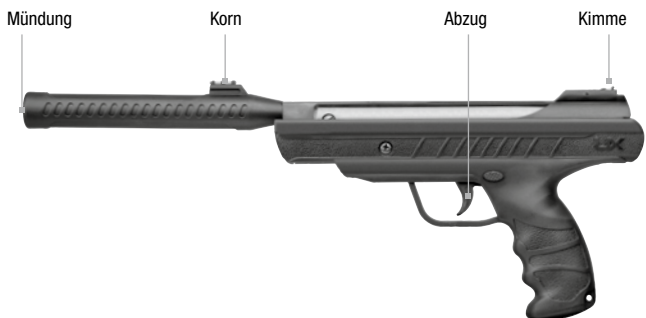



SICHERUNG

DE



ACHTUNG

- Hantieren Sie nur mit der Waffe, wenn diese gesichert ist.
- Achten Sie stets darauf, dass die Mündung in eine sichere Richtung zeigt.



PROBLEMLÖSUNGEN



PROBLEME

schlechte Schussleistung

Waffe schießt nicht

geringe Geschwindigkeit

MÖGLICHE GRÜNDE

| | Waffe gesichert | Lauf verschmutzt | Extreme Temperaturen | Falsche Munition | Munition falsch geladen | Visierung nicht richtig eingestellt | | | |
|--------------------------|-----------------|------------------|----------------------|------------------|-------------------------|-------------------------------------|--|--|--|
| schlechte Schussleistung | | ● | ● | ● | ● | ● | | | |
| Waffe schießt nicht | ● | | | ● | ● | | | | |
| geringe Geschwindigkeit | | ● | ● | ● | ● | | | | |



SPANNEN UND LADEN

DE



ACHTUNG

Nur Diabolos cal. 4,5 mm (.177) verwenden.

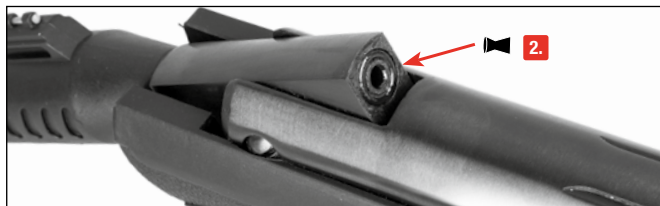
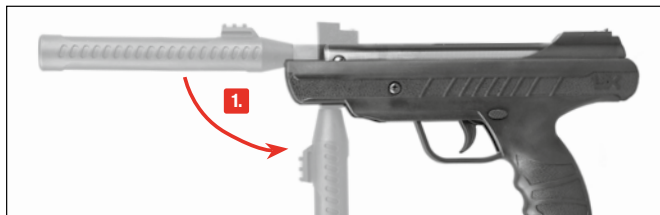



VISIERUNG EINSTELLEN

DE

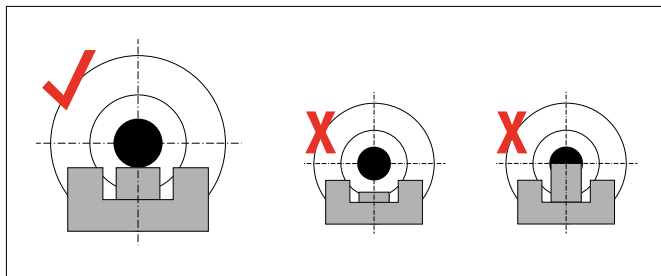

EINSTELLEN DER KIMME

Höhenverstellung

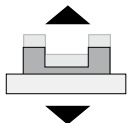

Schuss zu hoch



nach links drehen

Schuss zu tief



nach rechts drehen

Seitenverstellung



Schuss zu weit links



nach rechts drehen

Schuss zu weit rechts



nach links drehen



1. Entsichern



2. Abzug betätigen





ACHTUNG

- Entladen Sie die Waffe bevor Sie die Waffe reinigen.
- Schieben Sie den Stab niemals mit Gewalt in den Lauf, dies kann Beschädigungen verursachen.
- Reinigen Sie gelegentlich die äußeren Metallteile. Benutzen Sie dazu ein Tuch, auf das Sie leicht Waffenöl aufgetragen haben.
- Geben Sie niemals das Waffenöl direkt in den Lauf.

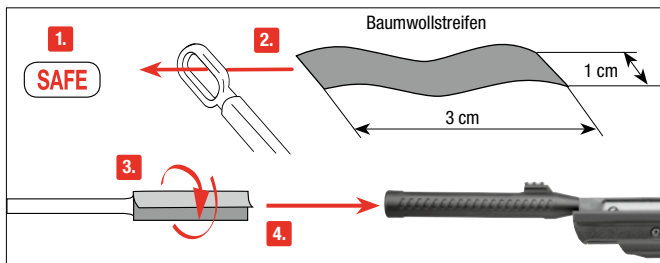

Sichern Sie die Waffe. Nehmen Sie einen ca. 30 cm langen, dünnen Stab. Wickeln Sie ein Stück Baumwolltuch um das Ende, benetzen Sie das Tuch mit etwas Waffen-Öl und reinigen Sie damit den Lauf.



MANIEMENT DES ARMES EN TOUTE SÉCURITÉ



Vous devez savoir manier votre arme correctement et de manière sûre et devez impérativement respecter les règles de base de tir en toute sécurité à chaque fois que vous manipulez l'arme.

- Maniez toujours l'arme comme si elle était chargée.
- Mettez toujours la sécurité avant de charger l'arme afin d'éviter tout tir involontaire.
- Ne mettez pas le doigt sur la détente et ne l'y placez que lorsque vous allez tirer.
- N'utilisez que les projectiles prévus pour cette arme.
- Pointez toujours la bouche de l'arme dans une direction non dangereuse.
- Il n'est permis de tirer avec l'arme que sur le lieu de résidence du propriétaire ou dans des zones de tir autorisées par la police, à condition que le projectile ne puisse pas sortir de la zone de tir. Veuillez toujours prendre en compte la zone de danger maximale du projectile.
- Ne transportez jamais l'arme lorsqu'elle est chargée. Ne la chargez que lorsque vous vous apprêtez à tirer.
- Ne dirigez jamais l'arme vers des personnes ni des animaux. Evitez les tirs pouvant faire ricocher le projectile. Ne tirez jamais sur des surfaces planes et dures, ni sur une surface d'eau car les projectiles peuvent ricocher.
- Avant de tirer, assurez-vous que l'objectif et les alentours ne présentent pas de danger.
- Vérifiez toujours que l'arme est déchargée avant de la transporter ou de la remettre à autrui.
- Veillez à maîtriser la direction dans laquelle la bouche de l'arme est pointée, même si vous trébuchez ou tombez.
- Pour des raisons de sécurité, portez des lunettes de protection lorsque vous tirez.
- Rangez toujours l'arme déchargée, séparée des munitions et dans un endroit sûr afin d'éviter que des personnes non autorisées (personnes non formées, enfants) puissent y avoir accès.
- Ne remettez cette arme, accompagnée du mode d'emploi, qu'à des personnes
 - qui sont le plus possible formées au maniement de cette arme et
 - qui ont atteint l'âge minimum légal selon la loi sur les armes en vigueur dans votre pays.
- Toute modification ou réparation de l'arme devra être effectuée par une entreprise spécialisée ou un armurier.
- Ne laissez jamais l'arme chargée sans surveillance.
- Déchargez toujours l'arme avant de la remettre à autrui.

RÉPARATION

Une arme qui ne fonctionne pas parfaitement est dangereuse. Il est difficile de réparer une arme soi-même, et un remontage incorrect peut entraîner des dysfonctionnements dangereux.

Attention : Seules des personnes spécialisées agréées ou un armurier peuvent contrôler et réparer l'arme.

**ATTENTION**

Pour votre sécurité et celle d'autrui, lisez attentivement le mode d'emploi avant d'utiliser l'arme pour la première fois. Les vendeurs, tout comme les acheteurs, ont l'obligation de respecter le règlement relatif à l'utilisation et à la possession d'armes à air comprimé. Il est interdit de procéder à toute modification de ce pistolet car cela pourrait entraîner un changement dans la classification correspondant à la législation sur les armes à feu. De plus, toute modification entraînerait l'annulation immédiate de la garantie du fabricant.

**MISE EN GARDE**

N'exhibez pas cette arme à air comprimé et ne la sortez pas en public. Cela pourrait prêter à confusion ou être considéré comme un délit. Les membres des forces de sécurité et la police pourraient la prendre pour une vraie arme à feu. Ne changez pas sa couleur ni les éléments d'identification pour qu'elle ressemble plus à une vraie arme à feu. Cela serait dangereux et peut être considéré comme un délit.

GARANTIE

La société Umarex s'engage à réparer ou à remplacer votre arme durant une période déterminée légalement à compter de la date d'achat, à condition que vous ne soyez pas responsable du défaut. Pour cela, remettez l'arme à un revendeur autorisé, décrivez-lui le problème et joignez le justificatif d'achat correspondant.

Les armes à air comprimé de la société UMAREX GmbH & Co. KG sont fabriquées conformément aux directives de conformité de l'institut allemand « Physikalisch-Technische Bundesanstalt (PTB) », à la loi fédérale, aux prescriptions CIP et au savoir-faire technique de la société UMAREX GmbH & Co. KG dans le domaine des armes.

Ainsi, nous ne pouvons être tenus responsables si, après exportation à l'étranger, cette marchandise ne répond pas aux prescriptions légales en vigueur dans le pays en question et si le possesseur/acheteur doit pour cette raison faire face à des difficultés juridiques ou toute autre conséquence pouvant découler de ce fait.

DONNÉES TECHNIQUES

| | |
|--------------------------------|--------------------------------|
| Numéro d'article | 2.4369 |
| | Trevox |
| Système / Source de Propulsion | Gas Piston |
| Calibre / Munitions | 4,5 mm (.177) Plomb |
| Capacité | 1 Coup (Plomb) |
| Énergie | < 7,5 J |
| Vitesse | jusqu'à 150 m/s |
| Dispositif de visée | Guidon fixe et hausse réglable |
| Detente | Simple Action |
| Couleur | noir |
| Sécurité | manuel |
| Longueur canon | 257 mm |
| Zone de danger s'étendant | 460 m |
| Poids | 1450 g |
| Longueur | 460 mm |



DÉSIGNATION DES PIÈCES

FR

Bouche

Guidon

Détente

Hausse



Sécurité

Canon





SÉCURITÉ

FR



ATTENTION

- Ne manipulez l'arme que lorsque la sécurité est enclenchée.
- Assurez-vous que la bouche est orientée dans une direction non dangereuse.



DYSFONCTIONNEMENTS



DYSFONCTIONNEMENTS

mauvaise performance de tir

l'arme ne tire pas

faible vitesse du projectile

CAUSES POSSIBLES

| | Sécurité de l'arme enclenchée | Canon encrassé | Températures extrêmes | Mauvaises munitions | Munitions mal chargées | Dispositif de visée mal réglé | | | |
|------------------------------|-------------------------------|----------------|-----------------------|---------------------|------------------------|-------------------------------|--|--|--|
| mauvaise performance de tir | | ● | ● | ● | ● | ● | | | |
| l'arme ne tire pas | ● | | | ● | ● | | | | |
| faible vitesse du projectile | | ● | ● | ● | ● | | | | |



ARMEMENT ET CHARGEMENT

FR



ATTENTION

Utilisez seulement des billes BB en acier de cal. 4,5 mm (.177)

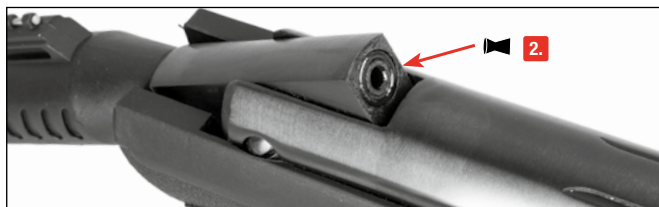
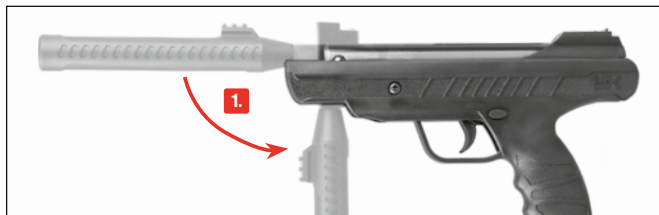



HAUSSE

FR

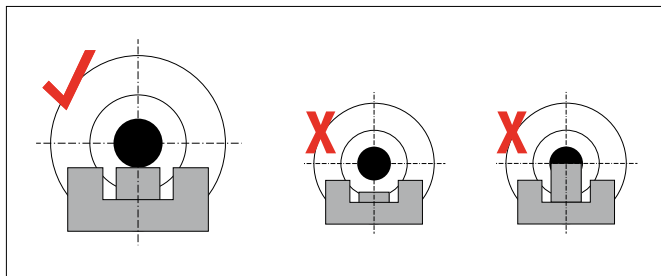

AJUSTAGE LA HAUSSE

Réglage en hauteur

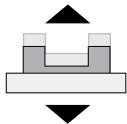

Tir trop haut



tourner vers la gauche

Tir trop bas



tourner vers la droite

Réglage latéral

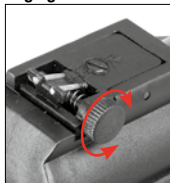

Tir trop à gauche



tourner vers la droite

Tir trop à droite



tourner vers la gauche



1. Enlevez la sécurité



2. Actionner la détente





ATTENTION

- Déchargez l'arme avant de nettoyer l'arme.
- N'enfoncez pas la baguette de nettoyage violemment dans le canon, car elle pourrait l'endommager.
- Nettoyez les pièces métalliques extérieures à l'aide d'un chiffon doux préalablement imbibé d'huile pour armes.
- Ne versez jamais l'huile de silicone directement dans le canon.

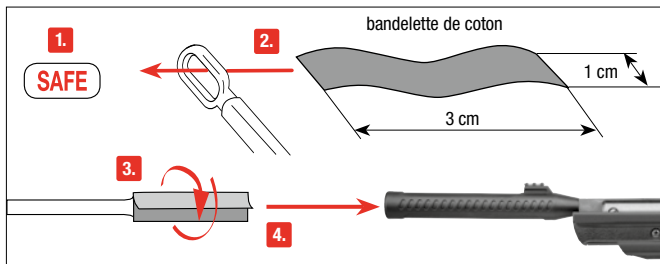

Mettez la sécurité de l'arme. Utilisez une tige fine d'une longueur d'env. 30 cm. Enroulez une bandelette de coton à son extrémité et nettoyez le canon avec une petite quantité d'huile de silicone.



Deberá estar familiarizado con el manejo correcto y seguro de su arma. Con respecto a las reglas básicas para disparar con seguridad, considere cada contacto con el arma como parte de su manejo.

- Trate el arma como si siempre estuviera cargada.
- Cargue siempre el arma con el seguro activado para evitar disparos involuntarios.
- Mantenga el dedo siempre fuera del gatillo y colóquelo solamente cuando vaya a disparar.
- Utilice únicamente proyectiles específicos para esta arma.
- Mantenga la boca del arma siempre en una dirección segura.
- Sólo está permitido disparar el arma en la vivienda del propietario o en las zonas de tiro autorizadas por la policía, siempre y cuando el proyectil no pueda llegar más allá del área de tiro. Para ello, tenga presente siempre la distancia máxima de peligro del proyectil.
- Nunca transporte el arma cargada. Cárguela solamente cuando tenga intención de disparar.
- Nunca apunte con el arma hacia personas o animales. Evite los disparos en los que el proyectil pueda rebotar: nunca dispare sobre superficies lisas y duras, ni al agua.
- Antes de disparar, asegúrese que el blanco y el entorno sean seguros.
- Antes de transportar el arma o de recibirla de manos de otra persona compruebe siempre que está descargada.
- Asegúrese de que, aunque tropezara o cayera, todavía puede controlar la dirección a la que apunta la boca del arma.
- Por motivos de seguridad, cuando vaya a disparar póngase siempre gafas protectoras.
- Guarde el arma siempre descargada, separada de la munición y en lugar seguro para evitar que personas no autorizadas (personas sin formación, personas menores de 18 años, niños) puedan acceder a ella.
- Entregue esta arma, junto con las instrucciones de uso, únicamente a aquellas personas que:
 - estén perfectamente familiarizadas con el manejo de esta arma
 - hayan cumplido la edad mínima correspondiente fijada por la legislación en materia de armas del país respectivo.
- Cualquier modificación o reparación del arma deberá llevarla a cabo una empresa especializada o un armero.
- Nunca deje sin vigilancia un arma cargada.
- Siempre que entregue un arma a otra persona, asegúrese de que está descargada.

REPARACIONES

Una arma que no funcione perfectamente es peligrosa. Es difícil reparar uno mismo un arma, y un ensamblaje incorrecto puede producir anomalías de funcionamiento peligrosas.

Atención: La comprobación y reparación del arma sólo pueden llevarla a cabo especialistas autorizados o un armero.

**ATENCIÓN**

Por su propia seguridad y la de los demás, lea detenidamente las instrucciones de uso antes de disparar el arma por primera vez. Vendedores y compradores están obligados a cumplir con las normas de uso y posesión de armas de aire comprimido. Queda prohibida cualquier modificación de esta arma, ya que ello podría implicar un cambio en su clasificación legal. En caso de modificación quedaría extinguida de inmediato la garantía del fabricante.

**AVISO**

No porte o muestre este arma de aire comprimido en público. Puede ser motivo de confusiones e ilegal. Miembros de las fuerzas de seguridad y la policía pueden tomarla por un arma de fuego real. No modifique el color ni los elementos identificativos para hacer que se parezca más a un arma de fuego real. Es peligroso y puede ser un delito.

GARANTÍA

La empresa Umarex se responsabiliza de reparar o sustituir su producto sin coste alguno en el plazo legalmente fijado a partir de la fecha de compra, siempre que el defecto no sea responsabilidad del propio usuario. Entregue el arma a un comerciante autorizado, describale el problema y adjunte el correspondiente comprobante de compra.

Las armas de aire comprimido de la empresa UMAREX GmbH & Co. KG se fabrican de conformidad con las normas de homologación del Instituto Federal PTB (Physikalisch-Technischer Bundesanstalt), con la Ley Federal alemana, la normativa que establece el centro CIP y la experiencia en fabricación de armas de UMAREX GmbH & Co. KG.

Por eso, no asumimos ninguna responsabilidad en el caso de que al exportar el arma a un país extranjero, ésta no cumpliera con la normativa legal local y el propietario o comprador tuviera que responder jurídicamente por dicho incumplimiento.

DATOS TÉCNICOS

| | |
|-----------------------------|------------------------------------|
| Número de artículo | 2.4369 |
| | Trevox |
| Sistema / Propulsión | Gas Piston |
| Kaliber / Munición | 4,5 mm (.177) Balines |
| Capacidad | 1 Tiros (Balin) |
| Energía | < 7,5 J |
| Velocidad | hasta 150 m/s |
| Dispositivo visor | Mira fija y mira trasera ajustable |
| Accion | Single Action |
| Color | negro |
| Seguro | manual |
| Longitud del cañón | 257 mm |
| Distancia máxima de peligro | 460 m |
| Peso | 1450 g |
| Longitud | 460 mm |



DESIGNACION

ES

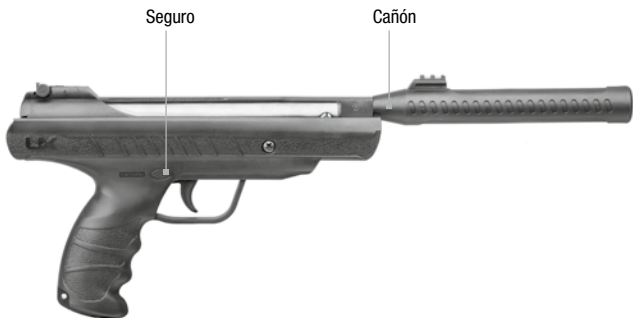



SEGURO

ES

ATENCIÓN

- Manipule la pistola sólo cuando esté asegurada.
- Asegúrese de que la boca apunte siempre en una dirección segura.



PROBLEMAS



PROBLEMAS

Potencia de disparo deficiente

El arma no dispara

Escasa velocidad de disparo

POSIBLES CAUSAS

| | Seguro activado | Cañón sucio | Temperaturas extremas | Munición errónea | Munición mal cargada | La mira no está bien ajustada | | | |
|--------------------------------|-----------------|-------------|-----------------------|------------------|----------------------|-------------------------------|--|--|--|
| Potencia de disparo deficiente | | ● | ● | ● | ● | ● | | | |
| El arma no dispara | ● | | | ● | ● | | | | |
| Escasa velocidad de disparo | | ● | ● | ● | ● | | | | |



ARMAMENTO E CARICAMENTO

ES



ATENCIÓN

Usare unicamente diabolo cal. 4,5 mm (.177).

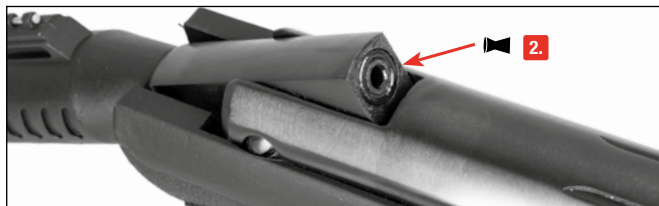
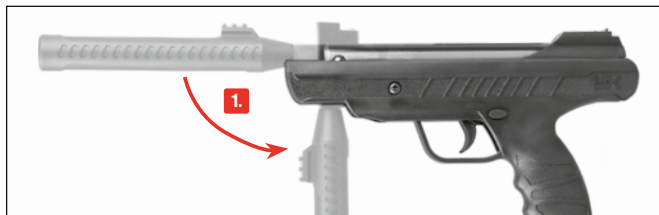



MIRA

ES

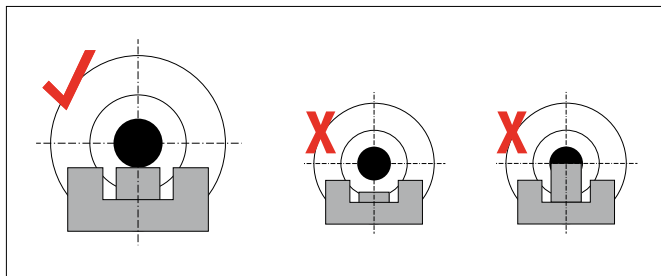

AJUSTE DE MIRA

Ajuste en altura

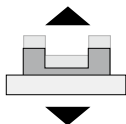

Disparo muy alto



gire hacia a la izquierda

Disparo muy bajo



gire hacia la derecha

Ajuste lateral

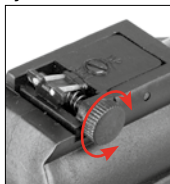

Disparo desviado hacia la izquierda



gire hacia la derecha

Disparo desviado hacia la derecha



gire hacia a la izquierda



DISPARO

ES

1. Desactive el seguro



2. Accione el gatillo





! ATENCIÓN

- Descargue el arma antes de limpiar el arma.
- No debe forzar la varilla de limpieza para introducirla dentro del cañón, porque podría dañar el arma.
- Limpie las piezas metálicas exteriores con un trapo suave, humedecido con aceite para armas.
- No vierta nunca aceite de silicona directamente dentro del cañón.

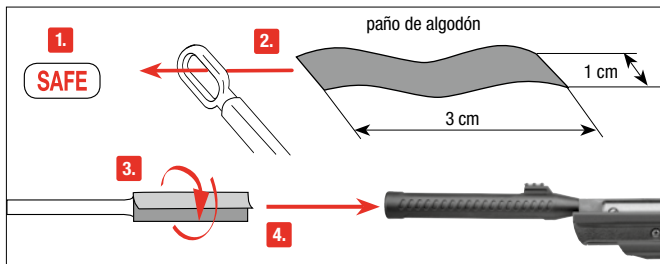

Asegure el arma. Coja una barra estrecha y larga de unos 30 cm. Enrolle un paño de algodón por el extremo, humedézcalo con un poco de aceite para armas y limpie el cañón con ayuda del mismo.



UTILIZZO SICURO DELLE ARMI AD ARIA COMPRESSA

IT

È molto importante essere assolutamente certi di quello che si fa quando si maneggia un'arma. Nell'ottica delle norme di base per un utilizzo sicuro delle armi ad aria compressa, ricordate sempre che toccare un'arma significa contemporaneamente maneggiarla.

- Trattate l'arma sempre come se fosse carica.
- Quando caricate l'arma, attivate sempre la sicura per evitare che involontariamente parta un colpo.
- Tenete il dito sempre al di fuori della guardia del grilletto, fino all'attimo prima di sparare.
- Utilizzate solo i proiettili indicati per quest'arma.
- Indirizzate l'arma sempre in una direzione sicura.
- Il tiro è ammesso soltanto all'interno della propria abitazione, in poligoni abilitati dalle autorità di polizia e su terreni che non possano essere oltrepassati dal proiettile. Considerate la portata massima del proiettile.
- Non trasportate mai un'arma carica. Caricatela soltanto se volete sparare.
- Non indirizzate mai l'arma verso persone o animali. Controllate che il proiettile non possa rimbalzare. Non sparate mai su superfici lisce, dure o sull'acqua.
- Accertatevi prima di sparare della sicurezza del bersaglio e delle sue immediate vicinanze.
- Controllate sempre se l'arma è scarica prima di trasportarla o prima di prenderla in consegna da un'altra persona.
- Tenete l'arma in modo da poterne controllare la direzione della volata anche se inciampate o state cadendo.
- Per motivi di sicurezza consigliamo di portare occhiali di protezione durante il tiro.
- Conservate e riponete al sicuro l'arma sempre scarica e al di fuori dalla portata di persone non autorizzate (inesperti, bambini) e separata dalle munizioni.
- Affidate l'arma, insieme con le istruzioni d'uso, esclusivamente a persone
 - che hanno perfetta dimestichezza con il maneggio di quest'arma, e
 - che hanno raggiunto l'età minima legale secondo la legge sulle armi in vigore nel vostro paese.
- Qualsiasi modifica o riparazione dell'arma deve essere effettuata esclusivamente da aziende o armaioli specializzati.
- Non lasciate mai incustodita l'arma carica.
- Scaricate l'arma prima di consegnarla ad altre persone.

RIPARAZIONE

Un'arma che non funziona perfettamente è pericolosa. È molto difficile riparare autonomamente un'arma, e un assemblaggio non corretto può determinare pericolosi malfunzionamenti. **Attenzione: Fate verificare e riparare l'arma soltanto da rivenditori specializzati/armaioli autorizzati.**

**ATTENZIONE**

Raccomandiamo, per la vostra e per l'altrui sicurezza, di leggere attentamente e completamente le istruzioni per l'uso prima di effettuare qualsiasi prova di sparo con quest'arma. L'acquirente ed il detentore hanno l'obbligo di seguire tutte le regole per il possesso e l'utilizzo di armi ad aria compressa. Qualsiasi modifica dell'arma può portare a una variazione della classificazione secondo le norme sul possesso e sull'uso delle armi, pertanto non è ammessa. In questo caso la garanzia del produttore decade con effetto immediato.

**AVVERTIMENTO**

Non agitare o brandire minacciosamente questa arma in pubblico - essa potrebbe essere considerata un'arma da fuoco vera e propria, cosa che costituisce un delitto. Non modificare in nessun caso il colore e le marcature dell'arma nell'intento di farla assomigliare ad una reale arma da fuoco. Un'operazione di questo tipo è pericolosa e può costituire un reato.

GARANZIA

Entro un anno dalla data di acquisto, la ditta Umarex procede gratuitamente alla riparazione o sostituzione dell'arma, a condizione che il difetto non sia imputabile all'utilizzatore. Affidate l'arma ad un rivenditore autorizzato, descrivete il problema e consegnate la prova di acquisto.

Le armi ad aria compressa prodotte dalla ditta UMAREX GmbH & Co. KG vengono costruite in conformità ai requisiti di certificazione dell'Ente federale fisico-tecnico (Physikalisch-Technische Bundesanstalt PTB), alle leggi federali, alla normativa CIP e in base al know how acquisito dalla ditta UMAREX GmbH & Co. KG nella fabbricazione di armi sportive.

In caso di esportazione all'estero, il produttore declina qualsiasi responsabilità per la non conformità dell'arma alle norme vigenti nel paese di destinazione nonché per eventuali difficoltà giuridiche e le relative conseguenze che ne potrebbero risultare per il proprietario/l'acquirente.

DATI TECNICI

| | |
|------------------------------|---|
| Codice art. | 2.4369 |
| | Trevox |
| Sistema / Alimentazione | Gas Piston |
| Calibro / Munizioni | 4,5 mm (.177) Pallini Diabolo |
| Capacità | 1 colpi (Diabolo) |
| Energia | < 7,5 J |
| Velocità | fino a 150 m/s |
| Mire | Mirino fisso e tacca di mira regolabile |
| Scatto | Single Action |
| Colore | nero |
| Sicura | manuale |
| Lunghezza canna | 257 mm |
| Distanza massima di pericolo | 460 m |
| Peso | 1450 g |
| Lunghezza | 460 mm |



DESCRIZIONE

IT

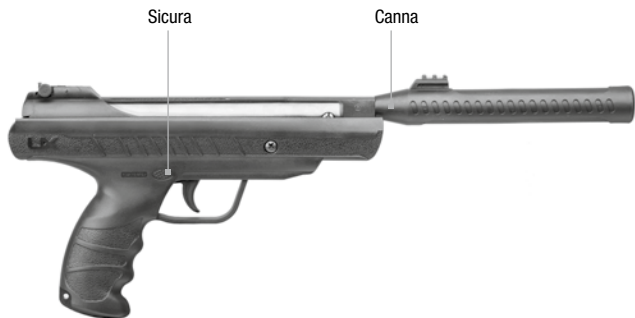
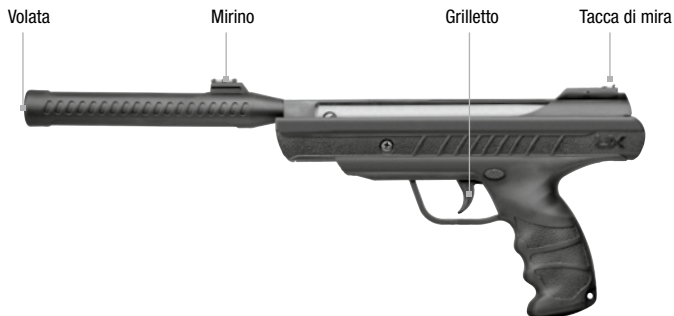



SICURA

IT



ATTENZIONE

- Accertarsi che la sicura sia inserita prima di iniziare a maneggiare l'arma.
- Indirizzate l'arma sempre in una direzione sicura.



PROBLEMI



PROBLEMI

L'arma non spara

Scarsa precisione

Velocità ridotta del proiettile

POSSIBILI CAUSE

| | Sicura attivata | Canna sporca internamente | Temperature estreme | Munizione sbagliata | Munizione caricata in maniera errata | Dispositivo di mira non regolato correttamente | | | |
|---------------------------------|-----------------|---------------------------|---------------------|---------------------|--------------------------------------|--|--|--|--|
| L'arma non spara | | ● | ● | ● | ● | ● | | | |
| Scarsa precisione | ● | | | ● | ● | | | | |
| Velocità ridotta del proiettile | | ● | ● | ● | ● | | | | |



ARMAMENTO E CARICAMENTO

IT



ATTENZIONE

Usare unicamente diabolo cal. 4,5 mm (.177).

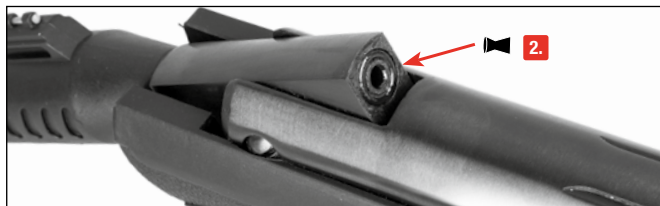
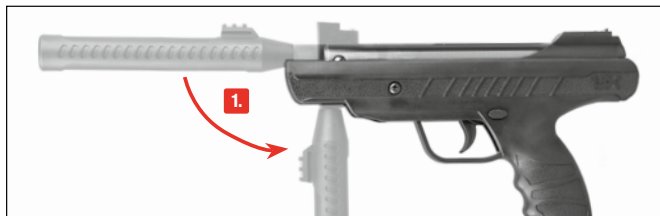



DISPOSITIVO DI MIRA

IT

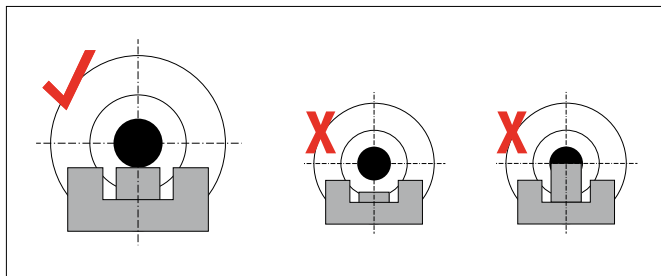

REGOLARE LA TACCA DI MIRA

Regolazione in altezza

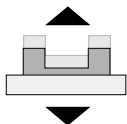

Tiro troppo in alto   ruotare verso sinistra

Tiro troppo in basso   ruotare verso destra

Regolazione laterale

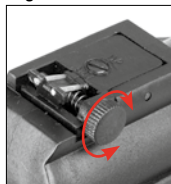

Tiro troppo a sinistra   ruotare verso destra

Tiro troppo a destra   ruotare verso sinistra



1. Disattivare la sicura



2. Azionare il grilletto

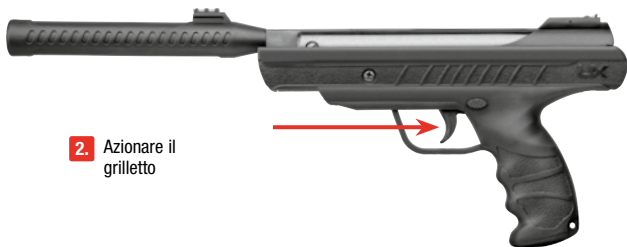



ATTENZIONE

- Prima di pulire l'arma, scaricarla.
- Non forzare mai l'asta all'interno della canna per evitare di danneggiarla.
- Ripulire di tanto in tanto le parti metalliche esterne. Servirsi a tale scopo di uno straccio leggermente imbevuto di olio per armi.
- Non introdurre mai l'olio per armi direttamente nella canna.

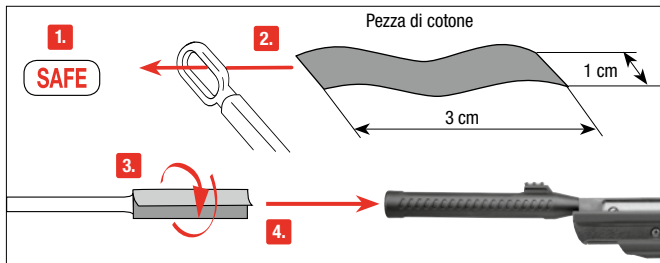

Attivare la sicura prima di procedere alla pulizia. Usare un'asta sottile lunga circa 30 cm.

Avvolgere una pezza di cotone intorno alla sua estremità, inumidire leggermente la pezza con olio per armi e pulire la canna.



Вам необходимо освоить правильное, безопасное обращение с оружием. Обратите внимание на то, что, согласно правилам безопасной стрельбы, обращением считается любое прикосновение к оружию.

- Обращайтесь с любым видом оружия так, как если бы оно было заряжено.
- При зарядке оружие необходимо всегда ставить на предохранитель, чтобы не произошло нежелательного выстрела.
- Никогда не держите палец на спусковом крючке; класть палец на спусковой крючок только для производства выстрела.
- Используйте только те патроны, которые предназначены для данного вида оружия.
- Всегда держите ствол оружия в безопасном направлении.
- Стрельба разрешается только в собственной квартире, на стрельбищах, имеющих официальное разрешение полиции, а также на обнесенных забором владениях, если заряд при выстреле не покинет их пределы. При этом необходимо учитывать опасную зону поражения пули.
- Никогда не перевозите заряженное оружие. Всегда заряжайте его непосредственно перед выстрелом.
- Никогда не направляйте оружие на людей или животных. Избегайте рикошета. Никогда не стреляйте в гладкие, твердые поверхности, а также на водную поверхность.
- Перед выстрелом убедитесь, что цель и окружающая территория безопасны.
- Всегда проверяйте, чтобы оружие не было заряжено при транспортировке или если принимаете его от другого лица.
- Убедитесь в том, что Вы способны контролировать направление ствола оружия при падении или если споткнетесь.
- В целях безопасности при стрельбе необходимо надевать защитные очки.
- Всегда храните оружие в разряженном виде и недоступном месте во избежание несанкционированного использования (лицами, не обученными специально, детьми) и отдельно от патронов.
- Передача этого оружия возможна только вместе с инструкцией по эксплуатации и только лицам,
 - которые в точности знают, как обращаться с этим оружием, и
 - которые имеют соответствующий минимальный возраст согласно закону об оружии в соответствующей стране.
- Любые изменения в конструкции оружия или его ремонт должны производиться только в специализированных фирмах или оружейным мастером.
- Никогда не выпускайте из рук заряженное оружие.
- Передавайте другим только незаряженное оружие.

РЕМОНТ

Не работающее должным образом оружие является опасным. Сложно отремонтировать оружие самому, а неправильная сборка может привести к опасным нарушениям его функций. **Внимание: Отдавайте оружие на проверку и в ремонт в авторизованные специализированные магазины/оружейным мастерам.**



УКАЗАНИЯ ПО ТЕХНИКЕ БЕЗОПАСНОСТИ АРАНТИЯ

RU

ВНИМАНИЕ

В целях Вашей собственной безопасности и безопасности других внимательно прочтите всю инструкцию по эксплуатации, прежде чем предпринять первую попытку обращения с оружием. Покупатель и владелец оружия обязаны соблюдать все правила пользования и владения пневматическим оружием. Любое изменение конструкции этого оружия может привести к изменению категории оружия и потому недопустимо. В этом случае гарантийные обязательства производителя автоматически теряют силу.



ПРЕДУПРЕЖДЕНИЕ

Не показывать это пневматическое оружие в общественных местах и не грозить им – оно может быть воспринято как настоящее оружие - это считается уголовно наказуемым деянием. Ни в коем случае не изменяйте цвет и маркировку пневматического оружия, чтобы еще более уподобить его внешний вид реальному огнестрельному оружию. Это опасно и может считаться уголовно наказуемым деянием.

ГАРАНТИЯ

Фирма Umagex бесплатно осуществит ремонт или замену оружия в течение установленного законом периода времени со дня покупки, если неисправность возникла не по вине владельца. Передайте оружие продавцу, имеющему соответствующую лицензию, опишите проблему и приложите документ, подтверждающий покупку.

Пневматическое оружие производства фирмы UMAREX GmbH & Co. KG изготавливается в соответствии с правилами Федерального физико-технического института (PTB), регламентирующими допуск к эксплуатации, федеральным законом, нормами CIP и оружейно-техническим ноу-хау фирмы UMAREX GmbH & Co. KG.

Таким образом, мы не берем на себя ответственность за то, если это оружие после экспорта за рубеж не соответствует действующим там правовым предписаниям, и у владельца/продавца из-за этого возникнут юридические трудности и последствия.

ТЕХНИЧЕСКИЕ ХАРАКТЕРИСТИКИ

| | |
|----------------------------------|--|
| Арт. № | 2.4369 |
| | Trevox |
| Система / Источник энергии | Gas Piston |
| Калибр | 4,5 мм /.177 пули Diabolo |
| Емкость магазина | 1 выстрел (Diabolo) |
| Энергия | < 7,5 Дж |
| Скорость полета пули | 150 м/с |
| Прицельное приспособление | Мушка неподвижная и регулируемая прицельная планка |
| Спусковой механизм | одинарного действия |
| Цвет | чёрный |
| Предохранитель | ручной |
| Длина ствола | 257 мм |
| Макс. протяженность опасной зоны | 460 м |
| Вес | 1450 г |
| Длина | 460 мм |



НАИМЕНОВАНИЕ

RU





ПРЕДОХРАНИТЕЛЬ

RU



ВНИМАНИЕ

- Обращайтесь с оружием, только поставив его на предохранитель.
- Всегда следите за тем, чтобы ствол оружия был направлен в безопасную сторону.



ПРОБЛЕМЫ



ПРОБЛЕМЫ

| |
|-----------------------------|
| Плохие показатели стрельбы |
| Оружие не стреляет |
| Слабая скорость полета пули |

ВОЗМОЖНЫЕ ПРИЧИНЫ

| Оружие стоит на предохранителе | Ствол загрязнен | Экстремальные температуры | Боеприпасы не подходят | Боеприпасы неправильно-но снаряжены | Неправильно установлен прицел | | | |
|--------------------------------|-----------------|---------------------------|------------------------|-------------------------------------|-------------------------------|--|--|--|
| | ● | ● | ● | ● | ● | | | |
| ● | | | ● | ● | | | | |
| | ● | ● | ● | ● | | | | |



ВЗВОД И ЗАРЯЖАНИЕ

RU



ВНИМАНИЕ

Использовать только пули Diabolo калибра 4,5 мм (.177).

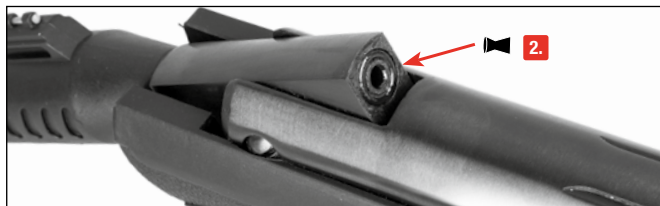
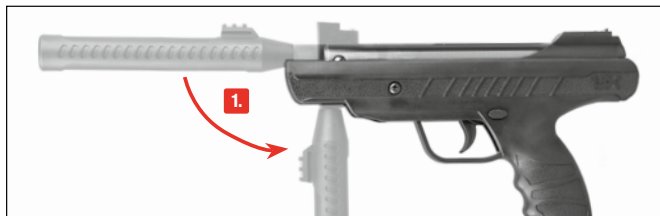



ПРИЦЕЛ

RU

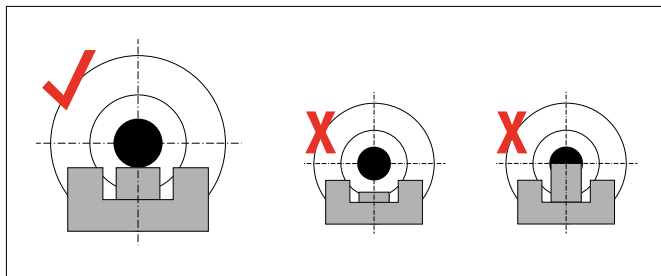

ПРИЦЕЛЬНАЯ ПЛАНКА

Регулировка по высоте

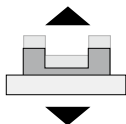

Попадание слишком высоко



вращать влево

Попадание слишком низко



вращать вправо

Регулировка в боковом направлении

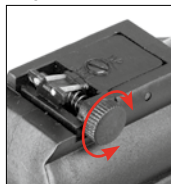

Попадание слишком далеко влево



вращать вправо

Попадание слишком далеко вправо



вращать влево



1. Снять с предохранителя.



2. Нажать на спусковой крючок.





ВНИМАНИЕ

- Разрядите оружие прежде чем чистить оружие.
- Никогда не вдвигайте стержень в ствол с применением силы, это может послужить причиной повреждений.
- Необходимо периодически чистить внешние металлические поверхности. Используйте для этого ткань, предварительно нанеся на нее немного оружейного масла.
- Никогда не заливайте оружейное масло непосредственно в ствол.

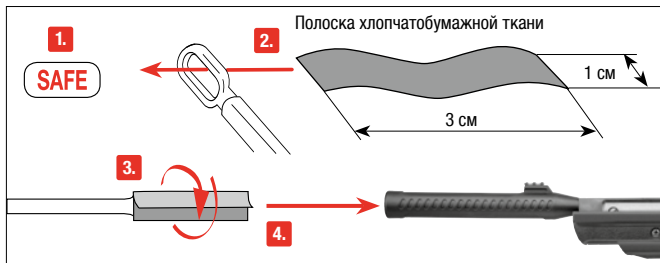

Поставьте оружие на предохранитель. Возьмите тонкий штырь длиной около 30 см. Намотайте на его кончик кусок хлопчатобумажной ткани, смочите его в оружейном масле и почистите с его помощью ствол.



Proszę zapoznać się z prawidłową, bezpieczną obsługą broni. Proszę pamiętać, że każde dotknięcie broni rozumiane jest jako jej obsługa. Taki stosunek do broni jest podstawową regułą bezpiecznego strzelania.

- Proszę traktować każdą broń jak załadowaną.
- Przy ładowaniu broni proszę zwrócić uwagę na jej zabezpieczenie, aby nie było możliwości oddania niekontrolowanego strzału.
- Palec powinien znajdować się zawsze poza językiem spustowym, można przyłożyć go tam tylko w celu oddania strzału.
- Proszę używać tylko pocisków przeznaczonych dla tej broni.
- Wylot lufy powinien być skierowany w bezpiecznym kierunku.
- Strzelanie jest dozwolone tylko we własnym mieszkaniu, na strzelnicach dopuszczonych do użytku przez policję oraz na innym własnym, spokojnym obszarze, którego wystrzelony nabój nie może opuścić. Proszę zwrócić uwagę na obszar niebezpieczeństwa pocisku.
- Podczas transportu broń nie powinna być załadowana. Proszę ją załadować tylko bezpośrednio przed oddaniem strzału.
- Proszę nigdy nie kierować broni w kierunku ludzi czy zwierząt. Należy unikać rykoszetu. Proszę nigdy nie strzelać na gładkie, twarde powierzchnie lub na powierzchnie wody.
- Przed oddaniem strzału należy upewnić się, czy cel strzału, jak również jego okolica, są bezpieczne.
- W przypadku transportu, a także przejęcia broni od innej osoby należy zawsze sprawdzić, czy broń nie została naładowana.
- Broń należy nosić zawsze w sposób umożliwiający określenie kierunku wylotu lufy w przypadku potknięcia się lub przewrócenia.
- W celach bezpieczeństwa, podczas wykonywania strzałów należy nosić okulary ochronne.
- Broń należy zawsze przechowywać w bezpiecznym miejscu, z dala od dostępu osób nieupoważnionych (osoby bez szkolenia, dzieci oraz osoby poniżej 18 roku życia) i amunicji. Broń nie może być załadowana.
- Broń wraz z instrukcją obsługi wolno przekazywać wyłącznie osobom,
 - które bardzo dokładnie zapoznały się z jej obsługą i
 - które zgodnie z ustawą o posiadaniu broni obowiązującą w danym kraju, osiągnęły minimalny wiek przewidziany w tej ustawie.
- Jakikolwiek zmiany lub naprawę broni powinny przeprowadzać tylko i wyłącznie wyspecjalizowane firmy lub rusznikarze.
- Proszę nigdy nie odkładać naładowanej broni.
- Nie należy podawać naładowanej broni osobom trzecim.

NAPRAWA

Broń, która nie funkcjonuje prawidłowo, jest niebezpieczna. Samodzielna naprawa nie jest łatwa, a niewłaściwe złożenie broni może doprowadzić do niebezpiecznych w skutkach zakłóceń w jej funkcjonowaniu.

Uwaga: Przeglądu i naprawy broni powinien dokonać autoryzowany sprzedawca/rusznikarz.

**UWAGA**

Dla bezpieczeństwa własnego oraz innych osób przed pierwszym użyciem broni proszę dokładnie i w całości przeczytać niniejszą instrukcję obsługi. Sprzedawcy i właściciele mają obowiązek przestrzegania wszelkich zasad dot. posiadania i stosowania broni pneumatycznej. Jakakolwiek zmiana przeprowadzana na broni może doprowadzić do zmiany w jej klasyfikacji i tym samym jest niedopuszczalna. W takim przypadku odpowiedzialność producenta wygasa w trybie natychmiastowym.

**OSTRZEŻENIE**

Nie pokazywać ani nie grozić tą bronią pneumatyczną w miejscach publicznych - może to doprowadzić do pomylenia z prawdziwą bronią i jest to czyn karalny. Nie wolno w żadnym wypadku zmieniać koloru i oznaczenia broni pneumatycznej, aby dopasować jej wygląd do prawdziwej broni strzeleckiej. Jest to niebezpieczne i może stanowić czyn karalny.

GWARANCJA

W ustawowym okresie gwarancyjnym liczonym od daty zakupu Firma Umarex gwarantuje bezpłatną naprawę lub wymianę broni, o ile usterka nie została zawiniona przez użytkownika. Broni należy oddać w autoryzowanym punkcie sprzedaży, opisać problem i dołączyć dowód zakupu.

Broni pneumatyczna firmy UMAREX GmbH & Co. KG produkowana jest zgodnie z przepisami Federalnego Urzędu Fizyczno-Technicznego (PTB), niemieckiego ustawodawstwa, przepisami CIP oraz wiedzą techniczną firmy UMAREX GmbH & Co. KG na temat broni.

Tym samym w przypadku eksportu towaru za granicę nie odpowiadamy za ewentualne problemy prawne właściciela/nabywcy wynikające z niezgodności towaru z przepisami obowiązującymi w danym kraju.

DANE TECHNICZNE

| | |
|----------------------------|--|
| Numer zamówienia | 2.4369 |
| | Trevox |
| System / Źródło | Gas Piston |
| Kaliber / Amunicja | kal. 4,5 mm / .177 śrut |
| Pojemność magazynka | 1 jednostrzałowy (śrut) |
| Energia | < 7,5 J |
| Prędkość | do 150 m/s |
| Przyrządy celownicze | Nieregulowana muszka i regulowana szczerbina |
| Spust | Pojedyńczego działania |
| Kolor | czarny |
| Bezpiecznik | manualny |
| Długość lufy | 257 mm |
| Maks. obszar zagrożenia do | 460 m |
| Waga | 1450 g |
| Długość całkowita | 460 mm |

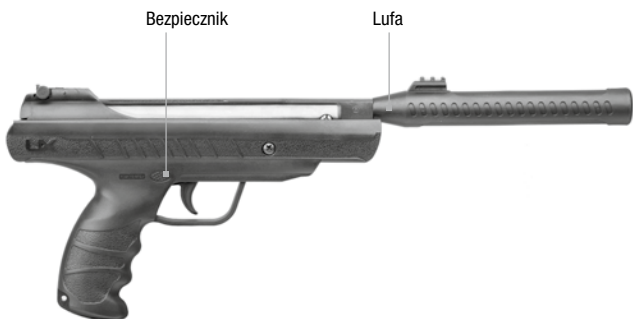
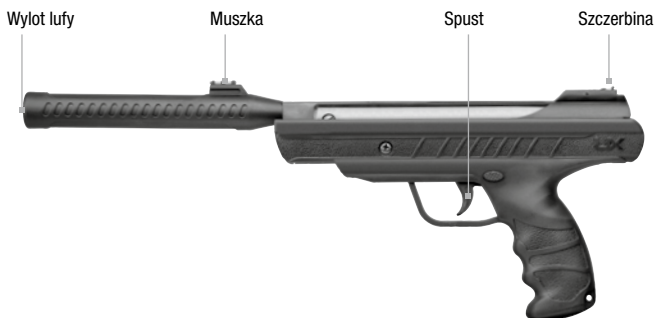



BEZPIECZNIK

PL



UWAGA

- Proszę posługiwać się wyłącznie zabezpiezczoną bronią.
- Należy stale kontrolować czy lufa jest skierowana w bezpiecznym kierunku.



PROBLEMY



| PROBLEMY |
|-----------------------|
| złe efekty strzelania |
| broń nie strzela |
| niska prędkość śrutu |

| MOŻLIWE PRZYCZYNY | | | | | | | | |
|--------------------|----------------------|-------------------------|--------------|----------------------------------|----------------------------|--|--|--|
| Broń zabezpieczona | Zanieczyszczona lufa | Ekstremalne temperatury | Zła amunicja | Niepoprawnie załadowana amunicja | Błędnie ustawiony celownik | | | |
| | ● | ● | ● | ● | ● | | | |
| ● | | | ● | ● | | | | |
| | ● | ● | ● | ● | | | | |



NAPINANIE I ŁADOWANIE

PL



UWAGA

Używać wyłącznie śrutu Diabolo 4,5 mm (.177).

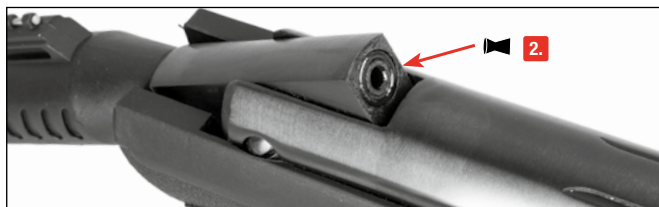
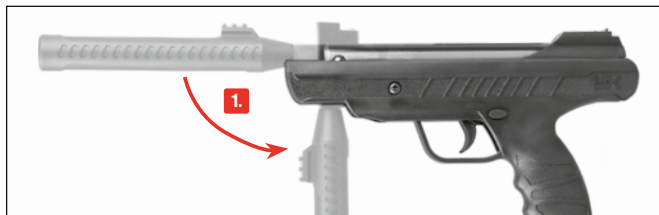



CELOWANIE

PL

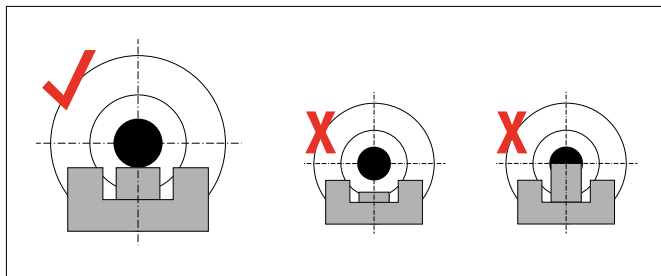

USTAWIANIE CELOWNIKA

Regulacja wysokości

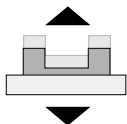

Strzał za wysoko



obrócić w lewo

Strzał za nisko



obrócić w prawo

Regulacja boczna



Strzał za bardzo na lewo



obrócić w prawo

Strzał za bardzo na prawo



obrócić w lewo



MOŻNA ODDAĆ STRZAŁ

PL

1. Odbezpieczyć



2. Nacisnąć spust.





UWAGA

- Przed czyszczeniem broni należy ją odbezpieczyć.
- Nie wolno nigdy wsuwać pręta siłą do lufy, ponieważ może to spowodować uszkodzenia.
- Od czasu do czasu należy wyczyścić zewnętrzne metalowe elementy, do tego celu należy użyć szmatki, na którą należy nanieść niewielką ilość oleju do czyszczenia broni.
- Nie dodawać oleju bezpośrednio do lufy.

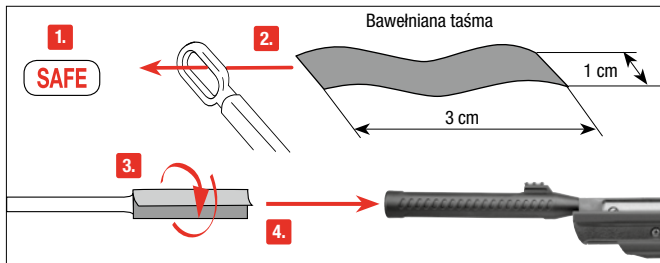

Proszę zabezpieczyć broń. Proszę wziąć długi, cienki wycior długości ok. 30 cm. Proszę obwinąć zakończenie w bawełnianą szmatkę nasączoną olejem przeznaczonym do broni i oczyścić nim lufę.



Silahınızın doğru ve güvenli şekilde kullanımına vakıf olmanız gerekmektedir. Güvenli silah atmanın ana kuralları açısından, silah ile her türlü temasın kullanım olarak anlaşıldığını göz önünde bulundurun.

- Her silaha, sanki dolu imiş gibi muamele edin.
- Silahı doldururken daima, kazara bir atış gerçekleşmeyecek şekilde emniyete alın.
- Parmağınızı her zaman tetik koruyucusunun dışında tutun ve sadece ateşlemek için tetiğin üzerine koyun.
- Sadece, bu silahla kullanılması öngörülen mühimmatı kullanın.
- Namluyu her zaman emniyetli bir yöne tutun.
- Sadece kendi evinizde, polis tarafından izin verilen atış poligonlarında ve çit veya duvarlarla çevrili bir mülk içerisinde, merminin bu alanın dışına çıkamayacağı koşullarda atış yapılabilir. Merminin tehlike menziline hesaba katın.
- Hiçbir zaman silahı dolu olarak taşımayın. Silahı sadece atış yapmak istediğiniz zaman doldurun.
- Silahı hiçbir zaman insanların veya hayvanların üzerine doğrultmayın. Kurşunların sekmeyeceği şekilde ateş etmeye dikkat edin. Hiçbir zaman kaygan, sert yüzeylere veya su yüzeylerine ateş etmeyin.
- Atış yapmadan önce hedefin ve çevredeki alanın güven altında olduğundan emin olun.
- Silahı taşımadan önce veya başka birinden teslim aldıktan hemen sonra, dolu olup olmadığını kontrol edin.
- Tökezlemeniz veya düşmeniz halinde bile namlunun yönünü kontrol edebileceğinizden emin olun.
- Emniyet açısından atış sırasında koruyucu gözlük kullanılmalıdır.
- Silahı daima boş olarak ve emniyetli halde, mühimmattan ayrı olarak ve yetkisiz kişilerin (eğitimi ve deneyimi olmayanların) izinsiz erişemeyeceği şekilde saklayın.
- Bu silahı kullanım kılavuzu ile beraber sadece
 - bu silahın kullanımına çok iyi vakıf olan ve
 - ilgili ülkenin silah mevzuatı uyarınca gerekli yaşı doldurmuş olan kişilere verebilirsiniz.
- Silahların üzerinde yapılacak her türlü değişiklik veya tamirat sadece uzman şirketler veya silah ustası tarafından yapılmalıdır.
- Hiçbir zaman dolu bir silahı elden bırakmayın.
- Sadece boşaltılmış silahları başka kişilere verin.

TAMİR

Kusursuz çalışmayan bir silah tehlikelidir. Bir silahı kendi başınıza tamir etmeniz zordur ve yanlış monte edilmesi tehlikeli fonksiyon arızalarına neden olabilir.

Dikkat: Silahınızı sadece yetkili bir uzman satıcı/silah ustası tarafından kontrol ve tamir ettirin.



GÜVENLİK BİLGİLERİ | GARANTİ

TR



DİKKAT

Hem kendinizin hem de başkalarının emniyeti için, silah ile ilk atış denemesine kalkışmadan önce, bu kullanım kılavuzunu tam olarak ve itina ile okuyun. Bu silahları satın alan veya sahibi olan kişiler, havalı silahların kullanılması ve bulundurulması ile ilgili tüm kurallara uymakla yükümlüdürler. Bu silah üzerinde yapılacak her türlü değişiklik silah mevzuatına göre yapılan sınıflandırmanın değişmesine neden olabilir ve bu sebeple yasaktır. Üreticinin vermiş olduğu garanti bu durumda geçerliliğini derhal kaybeder.



UYARI

Bu havalı silahı herkese açık yerlerde göstermeyin, onunla kimseyi tehdit etmeyin – gerçek silahlarla karıştırılabilir ve ayrıca bir suç teşkil eder. Kesinlikle, görünümünü gerçek bir ateşli silaha daha fazla benzetmek için havalı silahın rengini ve üstündeki işaretleri değiştirmeyin. Bunu yapmak tehlikeler yaratır ve ceza gerektiren bir suç teşkil eder.

GARANTİ

Satış tarihinden sonraki bir yıl içerisinde, silahta oluşan arıza kendi hatanızdan dolayı oluşmamış ise, Umarex şirketi silahınızı ücretsiz olarak tamir eder veya karşılığında yenisini verir. Silahı yetkili bir satıcıya götürün, ona sorunu anlatın ve satış belgesini sunun.

Umarex şirketi tarafından üretilen havalı silahlar, Fizik ve Teknik ile ilgili Federal Daire'nin (PTB) ruhsatlandırma şartlarına, federal yasaya, CIP talimatlarına ve de Umarex şirketi silah tekniği konusundaki deneyimlerine dayanılarak üretilmektedir.

Bu sebeple, eğer bu silah yurt dışına ihraç edildikten sonra o ülkenin hükümlerine uymadığı tespit edilirse ve sahibi/alıcısı bundan dolayı hukuki sorunlarla ve bunların sonuçları ile karşılaşarsa, şirketimiz herhangi bir sorumluluk kabul etmemektedir.

TEKNİK ÖZELLİKLER

| | |
|-------------------------|--|
| Ürün no. | 2.4369 |
| | Trevox |
| Sistem / Enerji kaynağı | Gas Piston |
| Kalibre / Mühimmat | cal. 4,5 mm /.177 Diabolo |
| Şarjör kapasitesi | 1 atış (Diabolo) |
| Enerji | < 7,5 J |
| Mermi hızı | 150 m/s |
| Nişangâh | Arpacık sabit, gez yükseklik ve sağ-sol ayarlı |
| Tetik | Tek hareketli |
| Renk | siyah |
| Emniyet | Manuel |
| Namlu uzunluğu | 257 mm |
| Azami tehlike bölgesi | 460 m |
| Ağırlık | 1450 g |
| Toplam uzunluk | 460 mm |



PARÇALARIN ADLARI

TR

Namlu ağızı

Arpacık

Tetik

Gez



Emniyet

Namlu





EMNİYET

TR



DİKKAT

- Silahı sadece, emniyetli halde iken elinize alın.
- Namlunun her zaman güvenli bir yöne doğrultulmuş olmasına dikkat edin.



PROBLEM ÇÖZÜMLERİ



| PROBLEMLER |
|-----------------------|
| Kötü atış performansı |
| Silah ateş almıyor |
| Merminin hızı düşük |

| OLASI NEDENLER | | | | | | | | |
|-----------------|-------------|-------------------|-----------------|-----------------------------|-----------------------------|--|--|--|
| Silah emniyette | Namlu kirlî | Aşırı sıcak/soğuk | Yanlış mühimmat | Mühimmat yanlış doldurulmuş | Nişangâh doğru ayarlanmamış | | | |
| | ● | ● | ● | ● | ● | | | |
| ● | | | ● | ● | | | | |
| | ● | ● | ● | ● | | | | |



KURMAK VE DOLDURMAK

TR



DİKKAT

Sadece cal. 4,5 mm (.177) Diabolo kullanın.

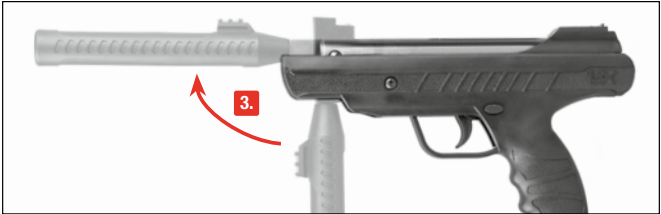
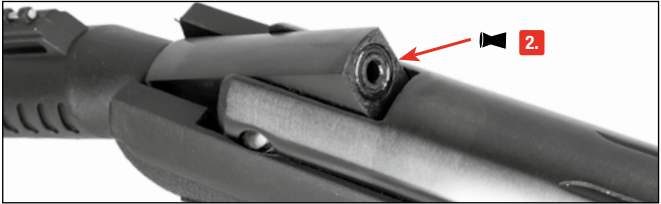
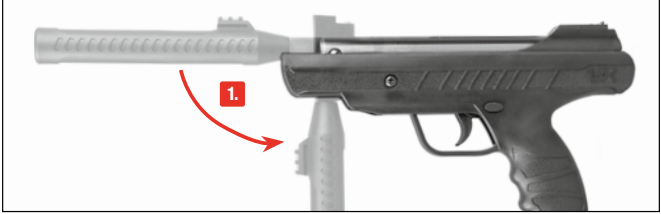



NİŞANGÂH

TR

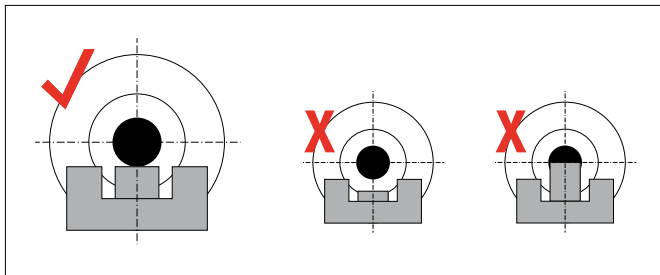

GEZ AYARI

Yükseklik ayarı

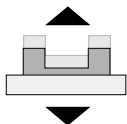

Atış yukarı
kaçıyor



Sola
döndürün

Atış aşağı
kaçıyor



Sağa
döndürün

Sağ-sol ayarı

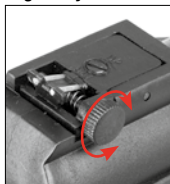

Atış sola
kaçıyor



Sağa
döndürün

Atış sağa
kaçıyor



Sola
döndürün



ATIŞ YAPMAK

TR

1. Emniyeti açın.



2. Tetiğe basın.





⚠ DİKKAT

- Silahı temizlemeden önce silahı boşaltın.
- Çubuğu hiçbir zaman namlunun içine zorla itmeyin, aksi halde hasar oluşabilir.
- Zaman zaman dıştaki metal parçaları temizleyin. Bunun için, üzerine biraz silah yağıyla nemlendirdiğiniz bir bez kullanın.
- Hiçbir zaman doğrudan namlunun içine silah yağı dökmeyin.

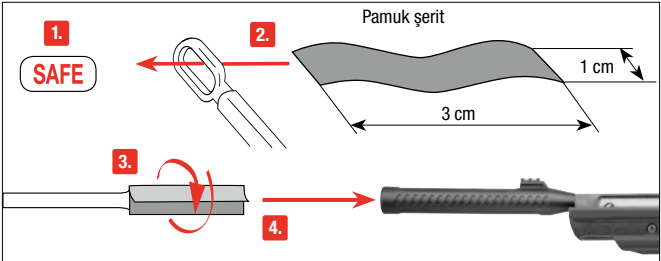

Silahı emniyete alın. Yakl. 30 cm uzunluğunda, ince bir çubuk kullanın. Ucuna bir parça pamuklu bez sarın, bezi biraz silah yağıyla ıslatın ve onunla namlunun içini temizleyin.



We reserve the right to make color and design changes and technical improvements. No responsibility is accepted for printing errors or incorrect information.

Änderungen in Farbe und Design, sowie technische Verbesserungen, Druckfehler und Irrtum vorbehalten. Alle Angaben ohne Gewähr.

Sauf modifications de la couleur et du design ainsi que des améliorations techniques, erreurs d'impression et erreur. Toutes les données sont fournies sans garantie.

Salvo modificaciones de color y de diseño así como mejoramientos técnicos, erratas y error. Todos los datos sin garantía.

Con riserva di modifiche di colore e di design, di miglioramenti tecnici, di errori di stampa e di sbagli. Tutte le informazioni senza garanzia.

Изменения цвета и дизайна, а также технические улучшения, опечатки и ошибки не исключены. Мы не гарантируем точность сведений.

Zastrzegamy sobie prawo do pomyłek, błędów w druku, zmian koloru i designu, jak również do wprowadzania technicznych ulepszeń. Wszystkie informacje bez gwarancji.

Renk, tasarım ve teknik değişiklikler yapma hakkı saklıdır. Baskı hatalarından ya da hatalı bilgilerden dolayı yasal sorumluluk kabul edilmez. Bilgiler için garanti verilmez.

© UMAREX GmbH & Co. KG

UMAREX

UMAREX GmbH & Co. KG

Donnerfeld 2

59757 Arnsberg | Germany

Phone: +49 29 32 / 638-01

Fax: +49 29 32 / 638-222

verkauf@umarex.de | sales@umarex.de

www.umarex.com